

**CUSTOMISED**

AUTO-BLOQUEO SELF-LOCKING COUPLE D'AUTOBLOCAGE SELBSTHEMMUNG	✓
RUEDA DE BRONCE BRONZE WHEEL ROUE EN BRONZE GETRIEBERAD AUS BRONZE	✓
EJE DELANTERO Y POSTERIOR FRONT AND REAR SHAFT ARBRE ARRIERE VORDERWELLE UND HINTERWELLE	✓
SENSOR HALL HALL SENSOR CAPTEUR HALL HALLENSOR	✓

Y MUCHO MÁS  
AND MANY MORE  
ET BEAUCOUP D'AUTRES  
UND VIELEN ANDEREN

REFERENCIA NUMBER REFERENCE REFERENZNUMMERN	TENSION NOMINAL NOMINAL VOLTAGE TENSION NOMINALE NOMINALSPANNUNG	PAR NOMINAL NOMINAL TORQUE COUPLE NOMINAL DREHMOMENT NOMINAL	VELOCIDAD NOMINAL NOMINAL SPEED VITESSE NOMINALE GESCHWINDIGKEIT NOMINAL	CORRIENTE NOMINAL NOMINAL CURRENT COURANT NOMINAL NOMINALSTROM	PAR DE ARRANQUE STARTING TORQUE COUPLE DE DEMARRAGE ANZUGSDREHMOMENT	CORRIENTE DE ARRANQUE STARTING CURRENT COURANT DE DEMARRAGE ANZUGSTROM	EJE AFTRE WELLE	CONEXIONES CONNECTIONS CONNEXIONS ANSCHLUSSART	ESQUEMA ELÉCTRICO WIRING DIAGRAM SCHEMA ELECTRIQUE SCHALTBILD	RELACION DE REDUCCIÓN TRANSMISSION RATIO RAPPORT DE REDUCTEUR ÜBERSERZUNG	PESO APROXIMADO APPROXIMATE WEIGHT POIDS APPROXIMATIF GEWICHT (ca.)	GRADO DE ESTANQUEIDAD WATER TIGHTNESS ÉTANCHÉITÉ FEUCHTIGKEITSSCHUTZKLASSE	MATERIAL RUEDA WHEEL MATERIAL MATERIAU ROUE MAT. DES SCHNECKENRADES	DISEÑO: A,B,C DESIGN: A,B,C DESSIN: A,B,C ABBILDUNG: A,B,C	CURVA CURVE COURBE KURVE
	U <sub>n</sub> (V)	M <sub>n</sub> (N.m./lbf.in)	n <sub>n</sub> (r.p.m.)	I <sub>n</sub> (A)	M <sub>a</sub> (N.m./lbf.in)	I <sub>a</sub> (A)				i	P (kg/lb.t)	IP			
111.3711.20.00	12	5 / 44.2	40	5	25 / 221.2	25	E22	C25	EE2	62:1	1.25 / 3.34	IP53	PLA	a	1
111.3711.30.00	24	5 / 44.2	40	2.5	25 / 221.2	13	E22	C25	EE2	62:1	1.25 / 3.34	IP53	PLA	a	1
111.3761.20.00	12	5 / 44.2	40	5	25 / 221.2	25	E23	C25	EE2	62:1	1.25 / 3.34	IP53	PLA	a	1
111.3761.30.00	24	5 / 44.2	40	2.5	25 / 221.2	13	E23	C25	EE2	62:1	1.25 / 3.34	IP53	PLA	a	1
111.3761.20.00E	12	5 / 44.2	40	5	25 / 221.2	25	E23	C25	F2	62:1	1.25 / 3.34	IP53	PLA	a	1
111.3761.30.00E	24	5 / 44.2	40	2.5	25 / 221.2	13	E23	C25	F2	62:1	1.25 / 3.34	IP53	PLA	a	1
111.3763.20.00	12	6 / 53.1	25	4	25 / 221.2	15	E23	C25	EE2	62:1	1.25 / 3.34	IP53	PLA	a	3
111.3763.30.00	24	6 / 53.1	25	2	25 / 221.2	8	E23	C25	EE2	62:1	1.25 / 3.34	IP53	PLA	a	3
111.4761.30.00	24	5 / 44.2	40	2.5	25 / 221.2	13	E23	C25	EE2	62:1	1.25 / 3.34	IP53	PLA	b	1
111.9031.20.00	12	3 / 26.5	70	6	25 / 221.2	34	E23	C25	EE2	62:1	1.25 / 3.34	IP53	PLA	a	2
111.9031.30.00	24	3 / 26.5	70	3	25 / 221.2	17	E23	C25	EE2	62:1	1.25 / 3.34	IP53	PLA	a	2
111.9039.20.00	12	1.5 / 13.2	240	8	14 / 123.9	46	E23	C26	EE1	49:4	1.25 / 3.34	IP53	PLA	a	4
111.9039.30.00	24	1.5 / 13.2	240	4	14 / 123.9	23	E23	C26	EE1	49:4	1.25 / 3.34	IP53	PLA	a	4
111.9041.30.00	24	5 / 44.2	40	2.5	25 / 221.2	13	E24	C25	EE2	62:1	1.30 / 3.48	IP53	BRO	a	1
111.9094.20.00	12	5 / 44.2	40	5	25 / 221.2	25	E52	C2	EE2	62:1	1.25 / 3.34	IP53	PLA	a	1
111.9107.30.00	24	1.5 / 13.2	240	4	14 / 123.9	23	E24/E53	C26	EE1	49:4	1.25 / 3.34	IP40	CEL	c	4
111.9199.20.00	12	3 / 26.5	100	6	20 / 177.01	48	E24	C26	F3	59:2	1.25 / 3.34	IP53	PLA	a	59
111.9199.30.00	24	3 / 26.5	100	3	20 / 177.01	24	E24	C26	F3	59:2	1.25 / 3.34	IP53	PLA	a	59

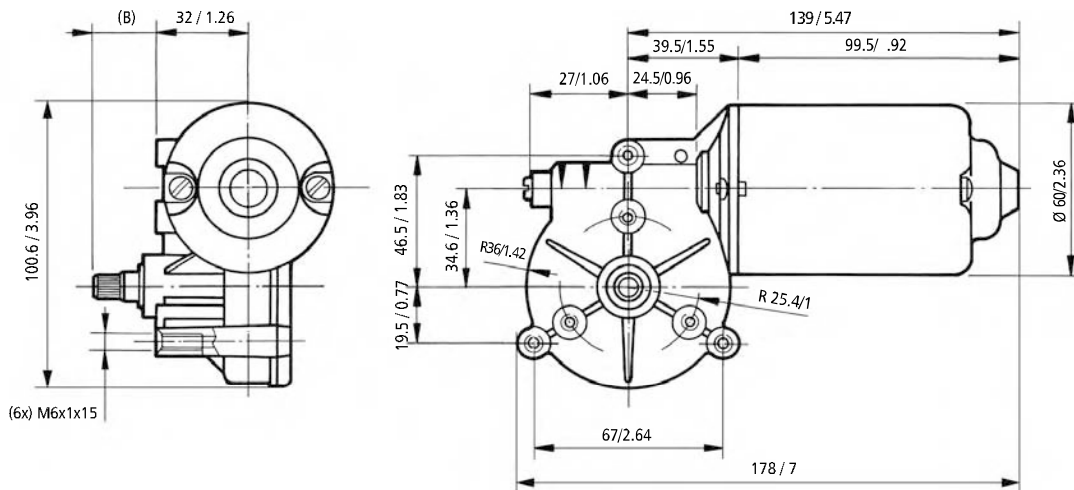

mm / in

## EJE - SHAFT - ARBRE - WELLE

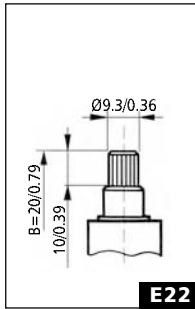

**E22**

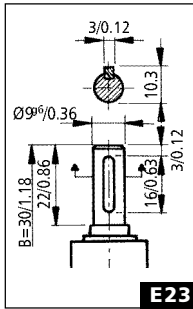

**E23**

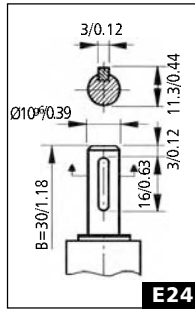

**E24**

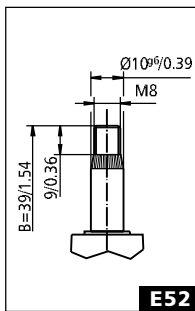

**E52**

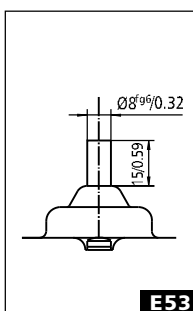

**E53**

## CONEXIONES - CONNECTIONS - CONNEXIONS - ANSCHLUSSART

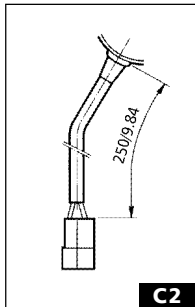

**C2**

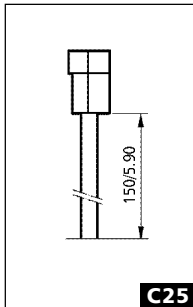

**C25**

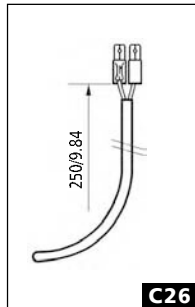

**C26**

## ESQUEMA ELÉCTRICO - WIRING DIAGRAM SCHÉME ÉLECTRIQUE - SCHALTBIKD

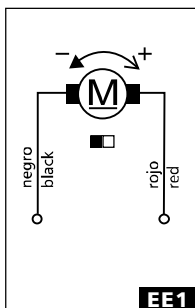

**EE1**

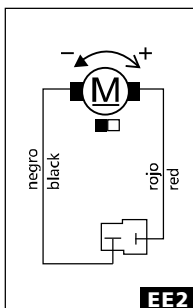

**EE2**

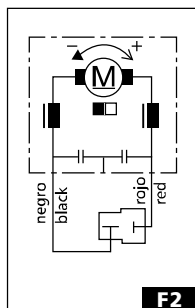

**F2**

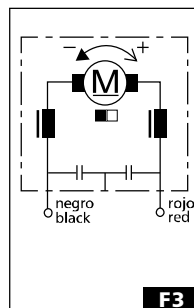

**F3**

## CURVAS - CURVES - COURBES - KURVEN

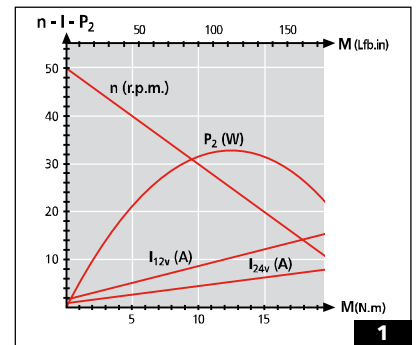

**1**

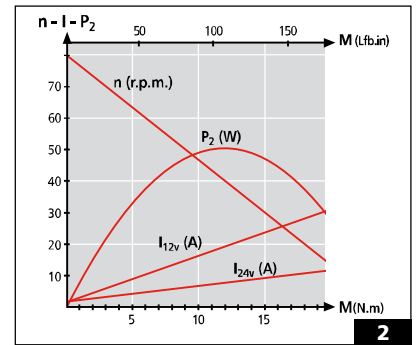

**2**

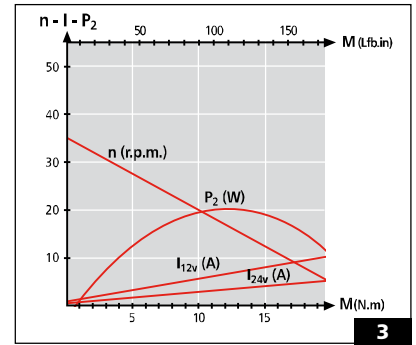

**3**

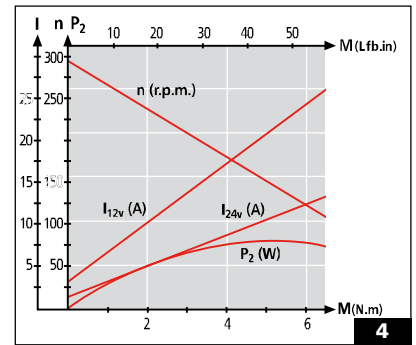

**4**

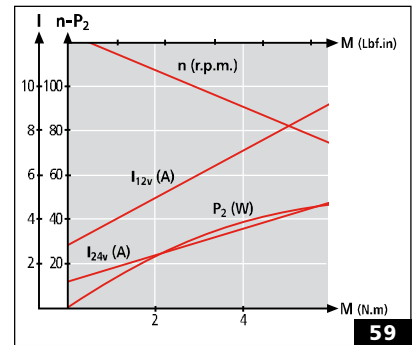

**59**