

Description and operating instructions

Rail Switch 2

INDUSTRIAL

RS2-5TX

Order No.

943 732-001

RS2-5TX/FX

Order No.

943 732-101



The Rail Switches RS2-5TX and RS2-5TX/FX have been especially designed for use in industrial environments. They support ETHERNET 10 MBit/s and Fast ETHERNET 100 MBit/s.

The Rail Switch modules support switched ETHERNET networks in accordance with IEEE standard 802.3 or 802.3u using copper and fiber optic technology. The switch modules are plugged onto the standard DIN rail. Because of their compact design the modules can be mounted in a terminal box.

The RS2-5TX modules have five 10/100 MBit/s twisted pair ports (10/100BASE-TX, RJ45 connectors). It is possible to connect up to five DTEs (data terminal equipment) or other TP/TX network segments to these ports using twisted pair cabling.

The RS2-5TX/FX modules have four 10/100 MBit/s twisted pair ports (10/100BASE-TX, RJ45 connectors) and one 100 MBit/s fiber optic port (100BASE-FX, MTRJ connector).

It is possible to connect up to four DTEs or other TP/TX network segments to the TP/TX ports using twisted pair cabling. One further DTE or an optical network component can be connected to the fiber port.

The TP ports support auto negotiation and autopolarity.

We have checked that the contents of the technical publication agree with the hardware and software described. However, it is not possible to rule out deviations completely, so we are unable to guarantee complete agreement. However, the details in the technical publication are checked regularly. Any corrections which prove necessary are contained in subsequent editions. We are grateful for suggestions for improvement.

We reserve the right to make technical modifications.

Permission is not given for the circulation or reproduction of this document, its use or the passing on of its contents unless granted expressly. Contravention renders the perpetrator liable for compensation for damages. All rights reserved, in particular in the case of patent grant or registration of a utility or design.

Copyright
© Hirschmann Electronics GmbH & Co. KG 2001
All Rights Reserved

Note

We would point out that the content of these operating instructions is not part of, nor is it intended to amend an earlier or existing agreement, permit or legal relationship. All obligations on Hirschmann arise from the respective purchasing agreement which also contains the full warranty conditions which have sole applicability. These contractual warranty conditions are neither extended nor restricted by comments in these operating instructions.

We would furthermore point out that for reasons of simplicity, these operating instructions cannot describe every conceivable problem associated with the use of this equipment. Should you require further information or should particular problems occur which are not treated in sufficient detail in the operating instructions, you can request the necessary information from your local Hirschmann sales partner or directly from the Hirschmann office (address: refer to chapter entitled „Notes on CE identification“).

Safety Instructions

This manual contains instructions which must be observed to ensure your own personal safety and to avoid damage to devices and machinery. The instructions are highlighted with a warning triangle and are shown as follows according to the degree of endangerment:

 **Danger!**
means that death, serious injury or considerable damage to property **will** result if the appropriate safety measures are not taken.

 **Warning!**
means that death, serious injury or considerable damage to property **can** result if the appropriate safety measures are not taken.

 **Caution!**
means that light injury or damage to property can result if the appropriate safety measures are not taken.

Note: is an important piece of information about the product, how to use the product, or the relevant section of the documentation to which particular attention is to be drawn.

Certified usage

Please observe the following:

 **Warning**
The device may only be employed for the purposes described in the catalog and technical description, and only in conjunction with external devices and components recommended or approved by Hirschmann. The product can only be operated correctly and safely if it is transported, stored, installed and assembled properly and correctly. Furthermore, it must be operated and serviced carefully.

Safety Guidelines Power Supply

Switch the basic devices on only when the case is closed.

 **Warning!**
The devices may only be connected to the supply voltage shown on the type plate.

The devices are designed for operation with a safety extra-low voltage. Thus, they may only be connected to the supply voltage connections and to the signal contact with the safety extra-low voltages (SELV) in compliance with IEC950/EN60950/ VDE0805.

For the case where the module is operated with external power supply: Use only a safety extra-low voltage in accordance with IEC 950/EN 60 950/VDE 0805 to power the system.

Connect the protective earth cable before connecting other cables. When removing the connections, remove the protective earth last.

Safety Guidelines Shielding Ground

Note: The shielding ground of the connectable twisted pairs lines is connected to the front panel as a conductor.

Beware of possible short circuits when connecting a cable section with conductive shielding braiding.

Safety Guidelines Housing

 **Warning!**
Only technicians authorized by Hirschmann are permitted to open the housing.

Note: The device is grounded via the separated ground screw. It is located on the left under the front panel.

Make sure that the electrical installation meets local or nationally applicable safety regulations.

 **Warning!**
The ventilation slits must not be covered so as to ensure free air circulation.

The distance to the ventilation slots of the housing has to be a minimum of 10 cm.

Never insert pointed objects (thin screwdrivers, wires, etc.) into the inside of the subrack! This especially applies to the area behind the socket connectors. Failure to observe this point may result in injuries caused by electric shocks.

Note: According to EN 60950 the device may only be operated in a fire protective housing.

Note: The housing has to be mounted in an upright position.

Safety Guidelines Environment

 **Warning!**
The device may only be operated in the listed ambient temperature range at the listed relative air humidity (non-condensing).

The installation location is to be selected so as to ensure compliance with the climatic limits listed in the Technical Data.

Staff qualification requirements

Note: Qualified personnel, as understood in this manual and in the warning signs, are persons who are familiar with the setup, assembly, startup, and operation of this product and are appropriately qualified for their job. This includes, for example, those persons who have been:

- trained or directed or authorized to switch on and off, to ground and to label power circuits and devices or systems in accordance with current safety engineering standards
- trained or directed in the care and use of appropriate safety equipment in accordance with the current standards of safety engineering
- trained in providing first aid.

General Safety Instructions

This device is electrically operated. Adhere strictly to the safety requirements relating to voltages applied to the device as described in the operating instructions!



Warning!

Failure to observe the information given in the warnings could result in serious injury and/or major damage.

Only personnel that have received appropriate training should operate this device or work in its immediate vicinity. The personnel must be fully familiar with all of the warnings and maintenance measures in these operating instructions.

Correct transport, storage, and assembly as well as careful operation and maintenance are essential in ensuring safe and reliable operation of this device.

These products are only to be used in the manner indicated in this version of the "Description and Operating Instructions".

Particular attention is to be paid to all warnings and items of information relating to safety.



Warning!

Any work that may have to be performed on the electrical installation should be performed by fully qualified technicians only.

Underlying specifications and standards:

The devices fulfil the following specifications and standards:

– EN 61000-6-2:1999 Fachgrundnorm – EMC requirements (immunity) for industrial area

– EN 55022:1998 – EMC requirements (emission) for Information Technology Equipment (ITE)

– EN 60950:1997 – Safety of Information Technology Equipment (ITE)

– EN 61131-2:1994 – Programmable Controllers

– CFR-47 Part 15:1997 – Code of Federal Regulations

– Germanischer Lloyd Part 1:1997 – Performance regulations (Prüfanforderungen für elektronische Betriebsmittel)

– UL 508:1998 – Underwriters Laboratories Inc. Standard for Safety



Notes on CE identification

The devices comply with the regulations of the following European directive:

89/336/EEC

Council Directive on the harmonization of the legal regulations of member states on electromagnetic compatibility (amended by Directives 91/263/EEC, 92/31/EEC and 93/68/EEC).

The EU declaration of conformity is kept available for the responsible authorities in accordance with the above-mentioned EU directives at:

Hirschmann Electronics GmbH & Co. KG
Automation and Network Solutions
Stuttgarter Straße 45-51
D-72654 Neckartenzlingen
Telephone ++49-7127-14-1538

The product can be used in the residential sphere (residential sphere, business and trade sphere and small companies) and in the industrial sphere.

– Interference immunity: EN 61000-6-2:1999
– Radio interference level: EN 55022:1998 Class A



Warning!

This is a Class A device. This equipment may cause radio interference if used in a residential area; in this case it is the operator's responsibility to take appropriate measures.

The precondition for compliance with EMC limit values is strict adherence to the construction guidelines specified in this description and operating instructions.

FCC Note:

This equipment has been tested and found to comply with the limits for a Class A digital device, pursuant to part 15 of the FCC Rules. These limits are designed to provide reasonable protection against harmful interference when the equipment is operated in a commercial environment. This equipment generates, uses, and can radiate radio fre-

quency energy and, if not installed and used in accordance with the instruction manual, may cause harmful interference to radio communications. Operation of this equipment in a residential area is likely to cause harmful interference in which case the user will be required to correct the interference at his own expense.



Recycling Note:

After its use, this product has to be processed as electronic scrap and disposed of according to the prevailing waste disposal regulations of your community / district / country / state.

1. Functional description

The 10/100BASE-T(X) ports of an RS2-5TX(/FX) represent a terminal connection for the connected LAN segment. You can connect single devices or complete network segments.

1.1 FRAME SWITCHING FUNCTIONS

Store and Forward

All data received by the RS2-5TX(/FX) from the system bus or at the ports is stored and checked for validity. Invalid and defective frames (> 1,518 bytes or > 1,522 bytes VLAN frames or CRC error) as well as fragments (< 64 bytes) are discarded. The RS2-5TX(/FX) forwards the valid frames.

Multi address capability

An RS2-5TX(/FX) learns all source addresses per port. Only packets with

- unknown addresses
- addresses learnt at this port
- a multi/broadcast address

in the destination address field are sent to this port.

An RS2-5TX(/FX) learns up to 1,000 addresses. This becomes necessary if more than one terminal device is connected to one or more ports. In this way several independent subnetworks can be connected to an RS2-5TX(/FX).

Learned addresses

An RS2-5TX(/FX) monitors the age of the learned addresses. The RS2-5TX(/FX) deletes address entries from the address table which exceed a certain age (300 seconds).

Note: Restarting deletes the learned address entries.

Tagging (IEEE 802.1Q)

The IEEE 802.1 Q standard designates the VLAN tag to be included in a MAC data frame for the VLAN and prioritizing functions. The VLAN tag consists of 4 bytes (2 bytes tag protocol identifier TPID, 2 bytes tag control information TCI). It is inserted between the source address field and the type field. Data packets with a VLAN tag are transmitted unchanged by the RS2-5TX(/FX).

1.2 SPECIFIC FUNCTIONS OF THE TP/TX INTERFACE

Link control

The RS2-5TX(/FX) monitors the connected TP/TX line segments for short-circuits or interrupts using regular Idle signals in accordance with IEEE standard 802.3 10/100BASE-T/TX. The RS2-5TX(/FX) does not transmit any data to a TP/TX segment from which it does not receive an Idle signal.

Note: A non-occupied interface is assessed as a line interrupt. The TP/TX line to terminal equipment which is switched off is likewise assessed as a line interrupt as the de-energised bus coupler cannot transmit Idle signals.

Auto polarity exchange

If the receive line pair is incorrectly connected (RD+ and RD- switched) polarity is automatically reversed.

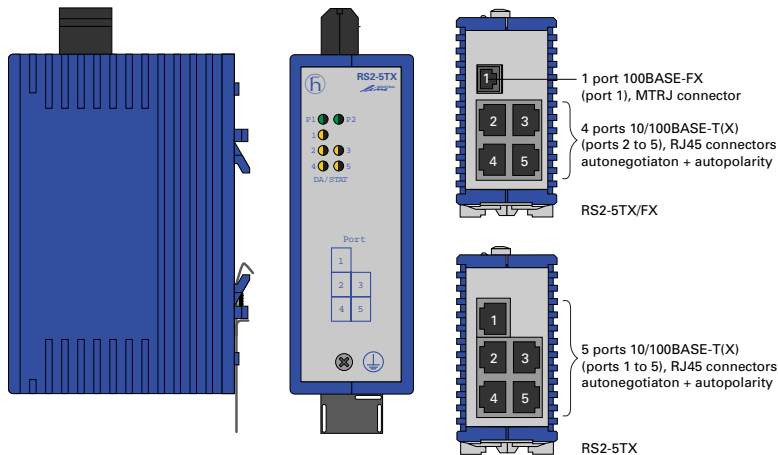

Fig. 1: Overview display elements and interfaces of the RS2-5TX(/FX)

1.3 SPECIFIC FUNCTIONS OF THE F/O INTERFACE

Link control (RS2-5TX(/FX))

The RS2-5TX(/FX) monitors the connected F/O line for interrupts using idle signals during frame pauses in accordance with IEEE standard 802.3 100BASE-FX. The RS2-5TX(/FX) transmits no data to an F/O line from which it is receiving no idle signal. Low Light Detection: If the optical input power decreases below the low light threshold the transmit and receive path will be disabled for data and the idle signal will be transmitted.

1.4 FURTHER FUNCTIONS AND FEATURES

Reset

The RS2-5TX(/FX) will be reset by the following action:

- input voltages fall below a threshold

After a reset the following action is carried out:

- initialization

1.5 DISPLAY ELEMENTS

Equipment status

These LEDs provide information about statuses which affect the function of the entire RS2-5TX(/FX).

P1 - Power 1 (green LED)

- lit: - supply voltage 1 present
- not lit: - supply voltage 1 less than 9.6 V

P2 - Power 2 (green LED)

- lit: - supply voltage 2 present
- not lit: - supply voltage 2 less than 9.6 V

Port Status

These LEDs display port-related information.

DA/STAT 1 to 5 - Data, Link status (green LED)

- not lit: - no valid link
- flashes: - data activity
- lit: - valid link

1.6 INTERFACES

10/100 Mbit/s connection (TP port)

Five (RS2-5TX(/FX): four) 10/100 Mbit ports (8-pin R45 sockets) allow DTEs or independent network segments complying with the standards IEEE 802.3 100BASE-TX / 10BASE-T to be connected. These ports support autonegotiation and the autopolarity function.

The socket casings are electrically connected to the front panel of the RS2-5TX(/FX). The pin configuration complies with MDI-X.

- Pin configuration of the RJ45 socket:

- TD+: pin 3, TD-: pin 6
- RD+: pin 1, RD-: pin 2
- remaining pins: not used.

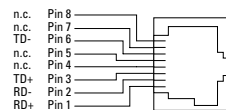

Fig. 3: Pin configuration of an TP/TX interface

100 Mbit/s connection (FX port)

The 100 Mbit/s port of the RS2-5TX(/FX) supports the IEEE 802.3 100BASE-FX FDX standard. It uses an MTRJ connector. The 100 Mbit/s port allows one further DTE or an optical network component to be connected.

5pin terminal block

The supply voltage and the indicator contact are connected via a 5pin terminal block with screw locking. If the terminal block is fitted the wrong way round, the device will still work correctly.



Warning!

The RS2-5TX(/FX) equipment is designed for operation with SELV. Only safety extra-low voltages to IEC950/EN60950/VDE0805 may therefore be connected to the supply voltage connections.

- **Voltage supply:** Redundant voltage supplies are supported. Both inputs are decoupled. There is no load distribution. With redundant supply, the power pack supplies the RS2-5TX(/FX) only with the higher output voltage. The supply voltage is electrically isolated from the housing.

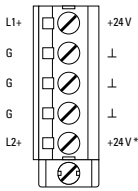

Fig. 5: Pin configuration of 5 pin terminal block

Ground connection

The RS2-5TX(/FX) is grounded via a separate screw connection.

2. Configuration

2.1 CONNECTING DTE AND OTHER NETWORK SEGMENTS

It is possible to connect up to five DTEs or other network segments to the 10/100 Mbit/s ports of the RS2-5TX using twisted pair cabling

It is possible to connect up to four DTEs or other TP/TX network segments to the 10/100 Mbit/s ports of the RS2-TX/FX using twisted pair cabling. One optical network component can be connected at 100 Mbit/s to the optical port using fiber optic cable (ref. Fig. 4).

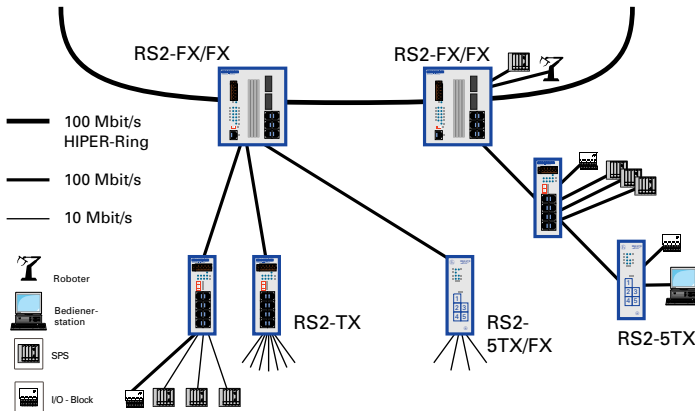

Fig. 4: Configuration with RS2-5TX (RS2-5TX/FX): Connection of up to 5 (4) data terminal equipments or further segments via TP/TX as well as connection via fiber optic cable with one optical port on the RS2-5TX/FX

3. Assembly, startup procedure and dismantling

3.1 UNPACKING, CHECKING

- Check whether the package was delivered complete (see scope of delivery).
- Check the individual parts for transport damage.

Warning!
Use only undamaged parts!

3.2 ASSEMBLY

The equipment is delivered in a ready-to-operate condition. The following procedure is appropriate for assembly:

- Pull the terminal block off the RS2-5TX(/FX) and wire up the supply voltage.
- Fit the RS2-5TX(/FX) on a 35 mm standard DIN rail to DIN EN 50 022.
- Attach the upper snap-on slide bar of the RS2-5TX(/FX) to the standard DIN rail and press it down until it locks into position.
- Fit the signal lines.

Notes:

- The front panel of the RS2-5TX(/FX) is grounded via a separate ground connection.
- Do not open the housing.
- The shielding ground of the twisted pair cables is electrically connected to the front panel.

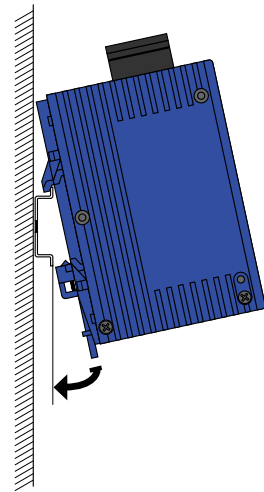

Fig. 6: Assembling the RS2-5TX(/FX)

3.3 STARTUP PROCEDURE

- You start up the RS2-5TX(/FX) by connecting the supply voltage via the 5-pin terminal block.

3.4 DISMANTLING

- To take the RS2-5TX(/FX) off the ISO/DIN rail, insert a screwdriver horizontally under the housing into the locking slide, pull it (without tipping the screwdriver) downwards and lift the RS2-5TX(/FX) upwards.

4. Further support

In the event of technical queries, please talk to the Hirschmann contract partner responsible for looking after your account or directly to the Hirschmann office. You can find the addresses of our contract partners - on the Internet (<http://www.hirschmann.de>).

Our support line is also at your disposal: Tel. +49(7127) 14-1538 (Fax -1542)

Answers to Frequently Asked Questions can be found on the Hirschmann internet site www.hirschmann.de

The FAQs are located under „Service“ in the Automation and Network Solutions section.

5. Technical data

General data

Operating voltage Buffer time	DC 9.6 V...32.0 V safety extra-low voltage (SELV) (redundant inputs decoupled) min. 10 ms at 24 VDC	
Potential difference between input voltage and housing	Potential difference to input voltage, +24 VDC: 32 VDC Potential difference to input voltage, ground: -32 VDC	
Current consumption	60 mA (RS2-5TX/FX: 120 mA) typ., at 24 VDC, no link 130 mA (RS2-5TX/FX: 180 mA) maximum, at 24 VDC, 5 ports fully loaded	
Overload current protection at input	non-changeable thermal fuse	
Dimensions W x H x D	40 mm x 145 mm x 80 mm	1.6 in x 5.7 in x 3.15 in
Weight	520 g	1.15 lb
Ambient temperature	0 °C to + 60 °C	32 °F to 140 °F
Storage temperature	- 20 °C to + 80 °C	-4 °F to 176 °F
Humidity	up to 90% (non condensing)	
Air pressure	min. 79 kPa	
Protection type	IP 20	
Radio interference characteristics	EN 55022 Class A, CFR-47 Part 15 Class A	
Interference immunity	Electro static discharge Electro magnetic fields Fast transients Shock tensions Line bound HF interferences	EN 61000-4-2 test toughness level 3 EN 61000-4-3 test toughness level 3 EN 61000-4-4 test toughness level 3 EN 61000-4-5 EN 61000-4-6 test toughness level 3
Resilience	Vibrations Shock	IEC 60068-2-6 Test Fc IEC 60068-2-27 Test Ea

Network size

TP/TX port 10BASE-T/100BASE-TX

Length of a twisted pair segment	100 m (328 ft) maximum
----------------------------------	------------------------

Interfaces

5 (RS2-5TX/FX: 4) TP/TX ports	RJ45 sockets, 10/100 MBit/s
-------------------------------	-----------------------------

Displays

Equipment status	1 x green LED	P1 – power 1, supply voltage 1 present
	1 x green LED	P2 – power 2, supply voltage 2 present
Port status	5 x green LED	DAT/STAT 1 to 5 – data, link status

Scope of delivery

Rail Switch RS2-5TX or RS2-5TX/FX incl. terminal block for supply voltage description and operating instructions	
--	--

Order number	
Rail Switch RS2-5TX	943 732-001
Rail Switch RS2-5TX/FX	943 732-101

Accessories

ETHERNET manual	943 320-011
Rail Power Supply RPS 60	943 662-001
Rail Power Supply RPS 120	943 662-011

Hirschmann Electronics GmbH & Co. KG
Automation and Network Solutions
Stuttgarter Straße 45-51
D-72654 Neckartenzlingen
Germany
Tel.: ++49 / 7127 / 14-1538
Fax: ++49 / 7127 / 14-1542
E-Mail: ans-support@nt.hirschmann.de
Internet: <http://www.hirschmann.com>

Printed in Germany
Subject to alterations

