

- Resistance to moisture and abrasion
- Strain relief
- Protection from wire pull-out
- Easy installation

DuraSeal
Heat-shrinkable nylon crimp splices and terminals

DuraSeal products insulate and protect electrical connections from mechanical abuse, wire pull-out, and abrasion while resisting water, salt, and other contaminants.

DuraSeal devices provide a tough, environmentally sealed wire connection. Their crimp barrel or terminal, encased in

rugged, heat-shrinkable nylon tubing lined with a special hot-melt adhesive, resists damage from abrasions and cuts.

DuraSeal devices retain flexibility and impact-resistance long after similar products have become brittle.

DuraSeal devices accommodate wire gauge sizes 22 to 10. They are color-coded for easy identification of gauge sizes, yet transparent for inspection of the finished splice.

Product dimensions (inches)

Butt splices

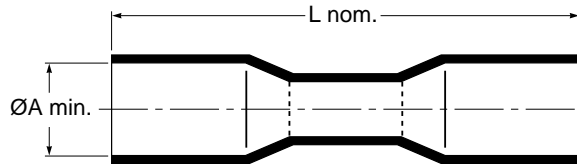

Part number	Butt splice dimensions			Wire dimensions		
	A min.	L nom.	Color	Conductor (AWG)	Insulation O.D. (max.)	Insulation O.D. (min.)
D-406-0001	.145	1.25	Red	22-18	.140	.055
D-406-0002	.180	1.25	Blue	16-14	.175	.080
D-406-0003	.250	1.50	Yellow	12-10	.245	.110

Fork terminals

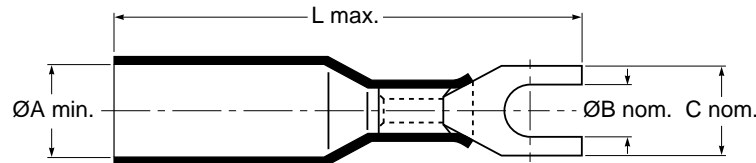

Part number	Fork terminal dimensions					Wire dimensions		
	A min.	B-stud recommended size	C nom.	L max.	Color	Conductor (AWG)	Insulation O.D. (max.)	Insulation O.D. (min.)
B-106-2401	.15	8	.31	1.26	Red	22-18	.150	.055
B-106-2402	.18	8	.31	1.38	Blue	16-14	.175	.080
B-106-2502	.18	10	.39	1.38	Blue	16-14	.175	.080
B-106-2403	.25	8	.31	1.50	Yellow	12-10	.250	.110
B-106-2503	.25	10	.39	1.58	Yellow	12-10	.250	.110

Ring terminals

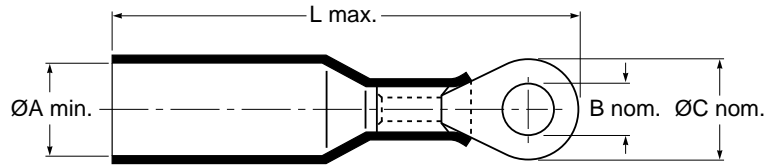

Part number	Ring terminal dimensions					Wire dimensions		
	A min.	B-stud recommended size	C nom.	L max.	Color	Conductor (AWG)	Insulation O.D. (max.)	Insulation O.D. (min.)
B-106-1401	.15	8	.31	1.26	Red	22-18	.150	.055
B-106-1501	.15	10	.39	1.34	Red	22-18	.150	.055
B-106-1601	.15	1/4	.47	1.42	Red	22-18	.150	.055
B-106-1801	.15	5/16	.55	1.54	Red	22-18	.150	.055
B-106-1991	.15	3/8	.70	1.70	Red	22-18	.150	.055
B-106-1402	.18	8	.31	1.30	Blue	16-14	.175	.080
B-106-1502	.18	10	.39	1.38	Blue	16-14	.175	.080
B-106-1602	.18	1/4	.47	1.44	Blue	16-14	.175	.080
B-106-1802	.18	5/16	.55	1.58	Blue	16-14	.175	.080
B-106-1992	.18	3/8	.70	1.73	Blue	16-14	.175	.080
B-106-1403	.25	8	.31	1.50	Yellow	12-10	.250	.110
B-106-1503	.25	10	.39	1.58	Yellow	12-10	.250	.110
B-106-1603	.25	1/4	.47	1.64	Yellow	12-10	.250	.110
B-106-1803	.25	5/16	.55	1.78	Yellow	12-10	.250	.110
B-106-1993	.25	3/8	.70	1.85	Yellow	12-10	.250	.110

Push-on terminals

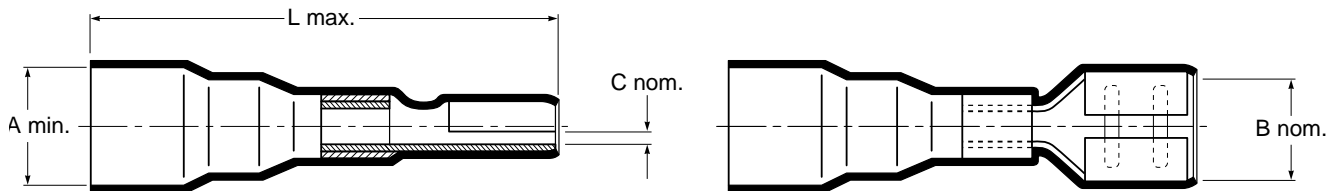

Part number	Push-on terminal dimensions					Wire dimensions		
	A min.	B nom.	C nom.	L max.	Color	Conductor (AWG)	Insulation O.D. (max.)	Insulation O.D. (min.)
B-106-3631	.150	.250	.032	1.20	Red	22-18	.150	.055
B-106-3632	.180	.250	.032	1.26	Blue	16-14	.175	.080
B-106-3633	.250	.250	.032	1.300	Yellow	12-10	.250	.110
B-106-3281	.150	.110	.020	.900	Red	22-18	.150	.055

Product dimensions (inches)

Tab terminals

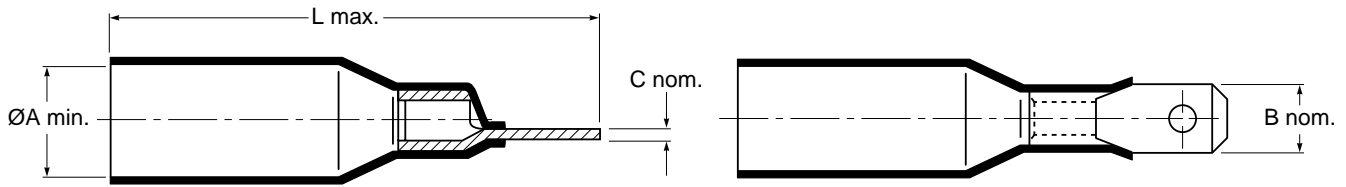

Tab terminal dimensions

Wire dimensions

Part number	A min.	B nom.	C nom.	L max.	Color	Conductor (AWG)	Insulation O.D. (max.)	Insulation O.D. (min.)
B-106-4631	.150	.250	.032	1.20	Red	22-18	.150	.055
B-106-4632	.180	.250	.032	1.26	Blue	16-14	.175	.080

Pin terminals

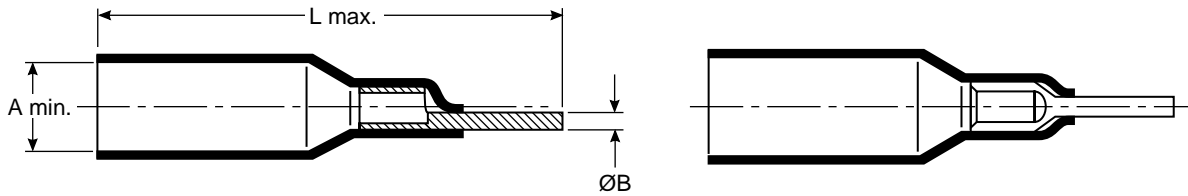

Pin terminal dimensions

Wire dimensions

Part number	A min.	B nom.	L max.	Color	Conductor (AWG)	Insulation O.D. (max.)	Insulation O.D. (min.)
B-106-6201	.150	.080	1.22	Red	22-18	.150	.055

Bullet terminals

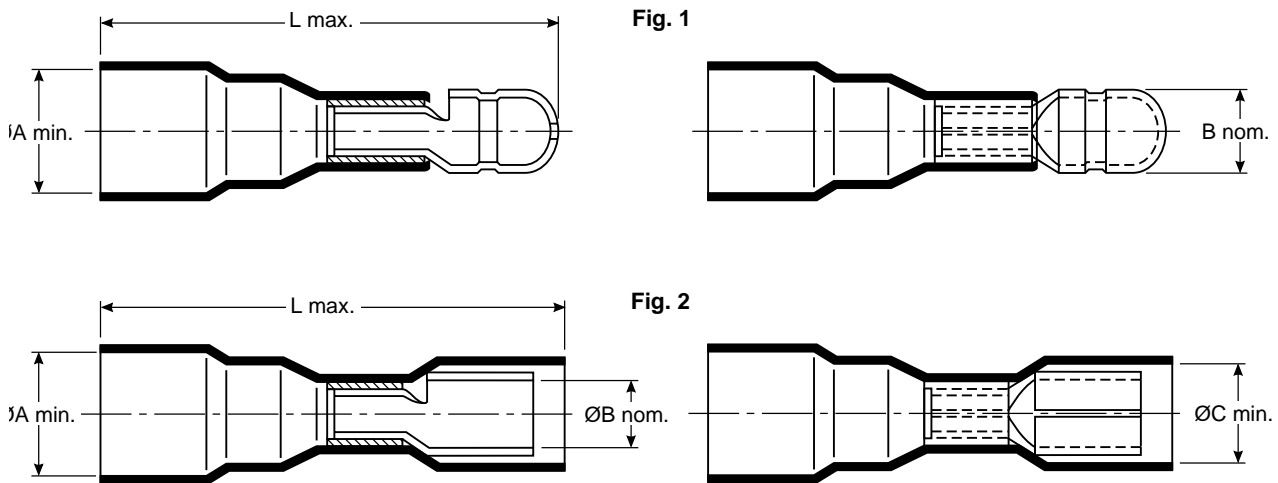

Bullet terminal dimensions

Wire dimensions

Part number	Fig.	Type	A min.	B nom.	C min.	L max.	Color	Conductor (AWG)	Insulation O.D. (max.)	Insulation O.D. (min.)
B-106-7401	1	M	.150	.150	-	1.32	Red	22-18	.150	.055
B-106-7502	1	M	.180	.200	-	1.36	Blue	16-14	.175	.080
B-106-8401	2	F	.150	.150	.220	1.20	Red	22-18	.150	.055
B-106-8502	2	F	.180	.200	.240	1.28	Blue	16-14	.175	.080

Product characteristics

	Property	Unit	Requirement	Method of test
Physical	Dimensions	Inches	None	See product dimensions
	Tensile strength	Pounds	8 to 40 lbs depending on AWG	UL486C, IEC512-8
	Property	Unit	Typical value	Method of test
Electrical	Voltage drop	Millivolts	Less than equal length of wire	MIL-S-81824, IEC512-2
	Insulation resistance	Megohms	10 ³ min.	MIL-STD-202 method 302
	Dielectric withstand voltage	Kilovolts	2.5	MIL-STD-202F method 301, IEC512-2
	Property	Unit	Requirement	Method of test
Chemical	Diesel fuel		Meet electrical test listed above after conditioning.	ASTM D 3032, ESA-603D
	Brake fluid			
	Antifreeze			
	5% salt water			
	Motor oil			
Environmental (Fluid resistance)	Humidity		Meet electrical test listed above after conditioning.	MIL-STD-202F method 106, IEC68-2-30
	Immersion			MIL-STD-202F condition C, IEC68-2-14 test NC
	Vibration			MIL-STD-202F method 201, IEC68-2-6
	Bending			UL486C, IEC512-8
	Thermal shock			MIL-STD-202F method 107, IEC68-2-14 test N
	Heat aging (168° @ 85°C)			MIL-STD-202F, IEC68-2-2
	Salt spray			MIL-STD-202F method 101, IEC68-2-11
Operating conditions	Temperature rating		-55°C to +125°C	None
	Minimum shrink temperature		180°C	None
	Voltage rating		600 Volt max	None

Approvals and reference documents

Agency approvals	UL listed component, file E87681, butt splices and terminals except quick connect terminals; file E157833, quick connect terminals
Reference documents	Raychem specifications RB-107, Specification DuraSeal crimp splices Raychem specifications RB-108, Specification DuraSeal crimp terminals DuraSeal selection guide (H54153) DuraSeal installation guidelines (H54154)

Ordering information

Standard packaging	Product supplied in bulk, 500 or 1000 pieces per box, depending on size. For other packaging options consult factory.
--------------------	---

DuraSeal is a trademark of Tyco Electronics Corporation.

All information, including illustrations, is believed to be reliable. Users, however, should independently evaluate the suitability of each product for their application. Tyco Electronics makes no warranties as to the accuracy or completeness of the information, and disclaims any liability regarding its use. Tyco Electronics only obligations are those in the Standard Terms and Conditions of Sale for this product and in no case will Tyco Electronics be liable for any incidental, indirect or consequential damages arising from the sale, resale, use, or misuse of the product. Tyco Electronics Specifications are subject to change without notice. In addition, Tyco Electronics reserves the right to make changes in materials or processing without notification to the Buyer which do not affect compliance with any applicable specification.

Tyco Electronics Corporation
Raychem
305 Constitution Drive
Menlo Park, CA 94025
U.S.A.
www.tycoelectronics.com

Tyco Electronics UK Ltd.
Raychem
Cheney Manor Industrial Estate
Swindon, Wiltshire SN2 2QE
U.K.

Tyco Electronics Raychem K.K.
Raychem
3816 Noborito, Tama-ku
Kawasaki 214-8533
Japan

Raychem Singapore Pte. Ltd.
Raychem
No. 26 Ang Mo Kio Ind. Park
Singapore 569507