

System pro M compact®

# Analogue and digital time and twilight switches

2CSC440007B0201



**ABB**



Controlling load switching in a system improves its functionality by rationalizing power consumption. This means that it is possible to decide when the heating will be switched on in an office based on the working hours, or to define the time when the lighting will be switched on in a car park based on the daylight level. Programming the control of electric loads according to the needs of each application obtains measurable advantages in terms of comfort and reduction of power wastage. The range of ABB Sace's modular analogue and digital time switches includes several versions that guarantee the opening and closing of electrical circuits according to a scheduled program. We offer a wide range of solutions for all main technical features (from switching capacity to minimum switching time, maximum number of commands per cycle, program steps, running or power reserve, accuracy, power loss etc.) to satisfy all market requirements.

# AT analogue time switches

Available in both daily and weekly versions, the new electromechanical time switches with 16 A contact (1 NO for the 1-module versions, and 1 NO/NC for the 2 and 3-module versions) can be operated according to a program or they can be set to a permanent ON function (ON-OFF for the 3-module version). AT1-R, AT2-R, AT2-7R, AT3-R and AT3-7R are equipped with a built-in battery, generally charged by the network voltage, which enables them to maintain their timing function even in case of lengthy power supply failures. Their installation is particularly suitable for lighting systems in shops, public buildings and schools, in heating and irrigation systems, etc.



## Main advantages

- The dial is clearly visible from the front
- Accurate and readable indication of the time
- The dial is completely accessible without tools
- Sealable and loss-proof cover to prevent unauthorised access
- RoHS compliant

## Main features

- 200 hours running reserve for AT1-R, AT3-R and AT3-7R and 150 hours for AT2-R and AT2-7R
- 1, 2 and 3 module versions
- Daily and weekly versions with and without reserve
- Loss-proof screw terminals
- Simple and compact design
- Minimum switching time:
  - 15' for AT1, AT1-R, AT3 and AT3-R (daily versions)
  - 30' for AT2 and AT2-R (daily versions)
  - 210' for AT2-7R (weekly version)
  - 120' for AT3-7R (weekly version)



# Application example

## AT3-7R time switches



### Operating principle

The AT electro-mechanical time switches enable to control the circuit opening/closing according to a daily or weekly program or to manually set permanent ON/OFF operation.

### Application environments

The AT electro-mechanical time switches are particularly indicated in any environment and situation where it is necessary to program system load operation according to a daily or weekly frequency (shop lighting system, public buildings, heating systems, irrigation systems, etc.).

### Example of installation

*As shown in the diagrams, one of the possible applications is to mount the AT3-7R electro-mechanical time switch inside the power supply circuit of a golf field. In this case the device programming enables the daily activation of the irrigation system at a preset time*

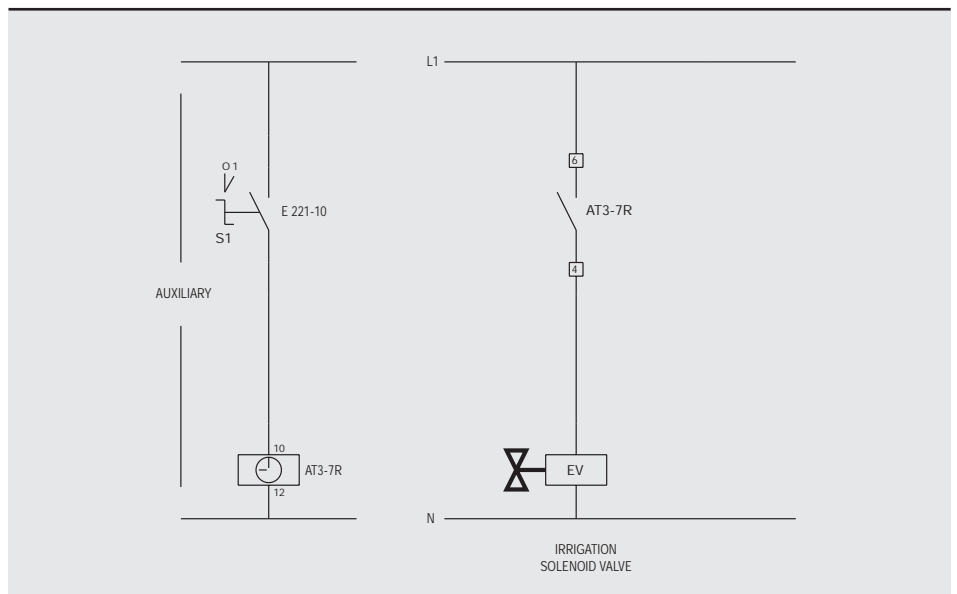
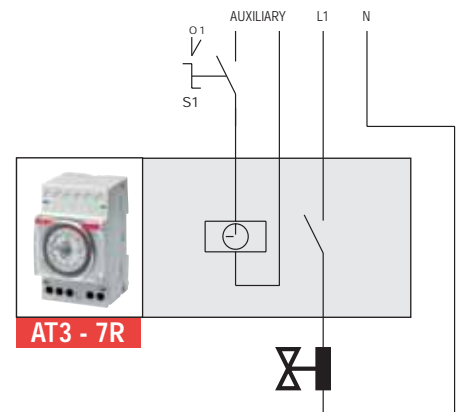

# Technical characteristics and order codes

## Technical features

Rated voltage	[V]	230 AC ± 10%
Switching capacity	[A]	16 (cosφ=1)
	[A]	3 (cosφ=0.6) for AT3, AT3-R, AT3-7R
	[A]	4 (cosφ=0.6) for AT1, AT1-R, AT2, AT2-R, AT2-7R
Contact type		1 CO for AT2, AT2-R, AT2-7R, AT3, AT3-R, AT3-7R
		1 NO for AT1, AT1-R
Frequency	[Hz]	50/60
Time base		quartz
Minimum switching time	[min]	15 for AT1, AT1-R, AT3, AT3-R
		30 for AT2, AT2-R
		210 for AT2-7R 120 for AT3-7R
Max. no. of commands per cycle	[n°]	96 for AT1, AT1-R, AT3, AT3-R
		48 for AT2, AT2-R, AT2-7R
		84 for AT3-7R
Operating accuracy	[s]	± 1s/ day
Running reserve	[h]	200 for AT1-R, AT3-R, AT3-7R
		150 for AT2-R, AT2-7R
Operating temperature	[°C]	-10...+55 for AT1, AT1-R, AT3, AT3-R, AT3-7R
		-10...+50 for AT2, AT2-R, AT2-7R
Power consumption	[VA]	0.5
Terminals		loss-proof screw
Installation		on DIN rail
Terminal size for cable	[mm²]	4 for AT1, AT1-R, AT3, AT3-R, AT3-7R
		2.5 for AT2, AT2-R, AT2-7R
Modules	[n°]	1 for AT1, AT1-R
		2 for AT2, AT2-R, AT2-7R
		3 for AT3, AT3-R, AT3-7R
Standards		EN 60730-1; EN 60730-2-7

## Order codes

CODE	TYPE	DESCRIPTION
2CSM204205R0601	AT1	daily analogue time switch, 1 NO contact, without running reserve, 1 module
2CSM204215R0601	AT1-R	daily analogue time switch, 1 NO contact, 200h running reserve, 1 module
2CSM204105R0601	AT2	daily analogue time switch, 1 CO contact, without running reserve, 2 modules
2CSM204115R0601	AT2-R	daily analogue time switch, 1 CO contact, 150h running reserve, 2 modules
2CSM204125R0601	AT2-7R	weekly analogue time switch, 1 CO contact, 150h running reserve, 2 modules
2CSM204225R0601	AT3	daily analogue time switch, 1 CO contact, without running reserve, 3 modules
2CSM204235R0601	AT3-R	daily analogue time switch, 1 CO contact, 200h running reserve, 3 modules
2CSM204245R0601	AT3-7R	weekly analogue time switch, 1 CO contact, 200h running reserve, 3 modules

## Overall dimensions

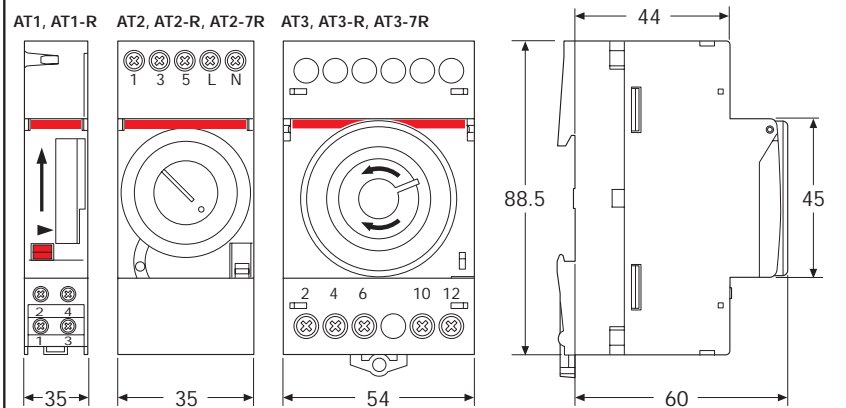

## Connection diagrams

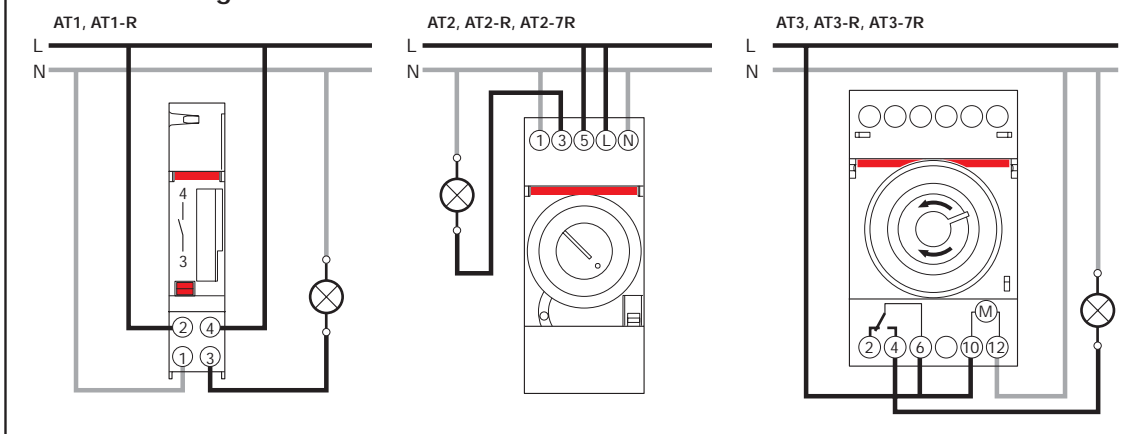

## DT digital time switches

ABB Sace's range of digital time switches is equipped with a permanent EEPROM memory to ensure that the scheduled program is followed and the date and hour settings are maintained even in case of lengthy power supply failures. The range, used for both daily and weekly programming, includes single/double channel versions with a change-over contact with a switching capacity of 16(10) A. The programming key, available on the DT...K versions, provides easy and quick programming of multiple switches, avoiding the number of mistakes due to successive modifications. The DT1-IK/DCF time switch can be combined with the DT-DCF antenna for automatic synchronization of one or more switches, even if mounted in unsupervised places, with Frankfurt DCF77 official time. New features include a holiday mode that allows forcing of the ON-OFF output for a certain period, a random mode used to simulate event presence, and a waiver mode to carry out waivers remotely or locally.

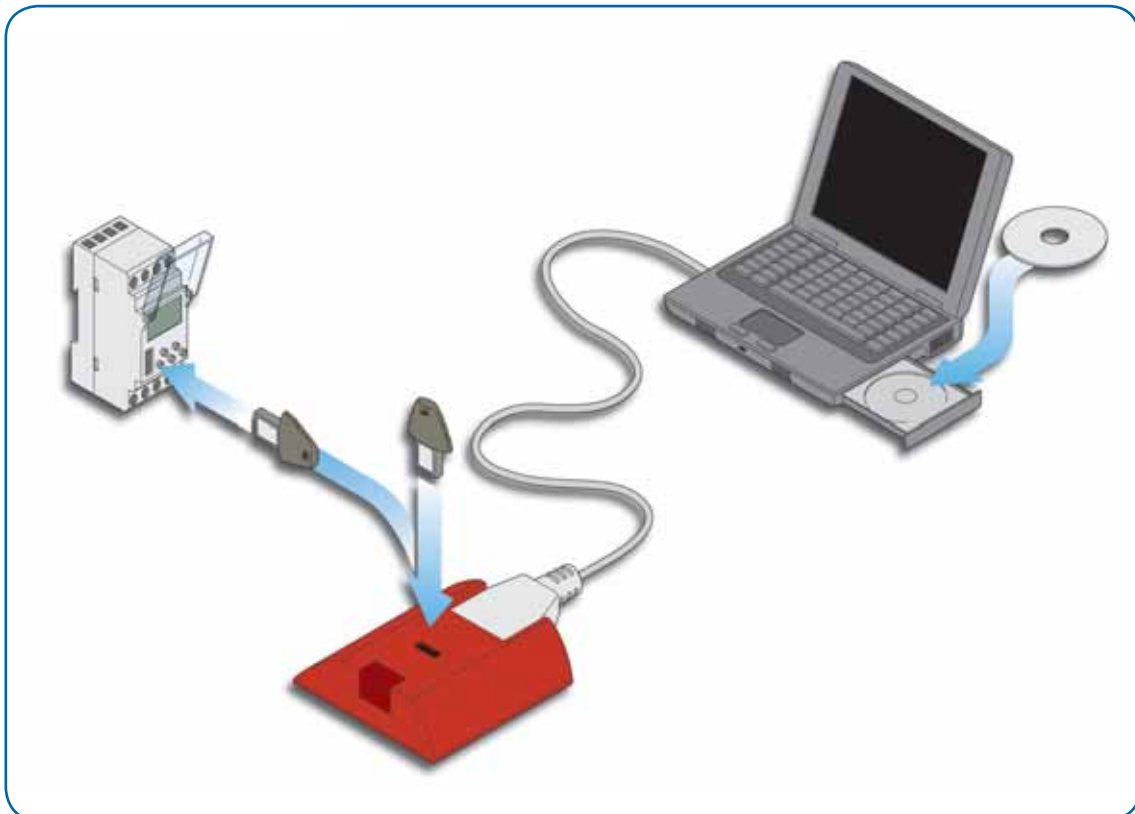

### Main advantages

- Simple to program: the menu display allows the user to manage the time programming, visualisation and settings with just a single touch
- Programming key: to make permanent changes or to copy and save the program
- Pulse mode: allows pulses of length from 1 second to 30 minutes
- Holiday mode: allows forcing of the ON-OFF output for a specific period
- Random mode: simulates the event presence, activating the loads following a random scheme
- Waiver mode: to carry out waivers remotely or locally (only on DT1-IK)
- 16 (10) A potential-free contact(s)
- Backlit display
- Lithium battery
- Sealable and loss-proof cover
- RoHS compliant

### Main features

- 56 program steps
- Minimum time between two steps of 1 minute
- Keyboard can be locked with key or code
- Programming possible even in case of power supply failure
- Automatic change of summer/winter time
- Overall dimensions of 2 modules
- Simple and compact design
- 5 years power reserve
- Loss-proof screw terminals

### Available accessories

- DCF77 antenna
- Programming and locking keys
- Software and software plug-in adaptor with USB cable



# Application example

## DT2 time switches

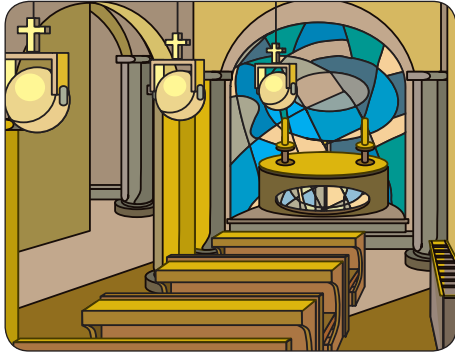

### Operating principle

The DT two-channel digital time switches enable to open and close circuits according to a daily or weekly program, controlling single loads or group of loads even when they require different time controls with a common time reference.

In this example, the digital time switch DT2 allows the operation of heating as well as lighting systems of a church when services are performed; when no service is performed, the device only controls the heating system.

### Application environments

The DT2 two-channel digital time switches are particularly indicated in environments and situations requiring the management of multiple loads according to a time program flexible enough to include or exclude their application based on the day of the week (offices, schools, public areas, etc.).

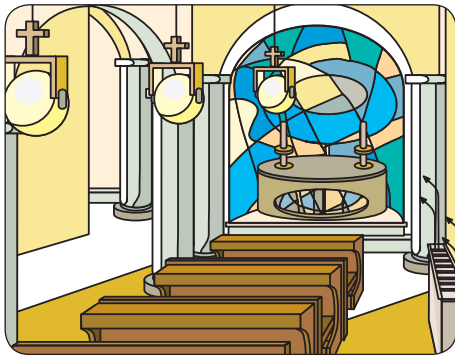
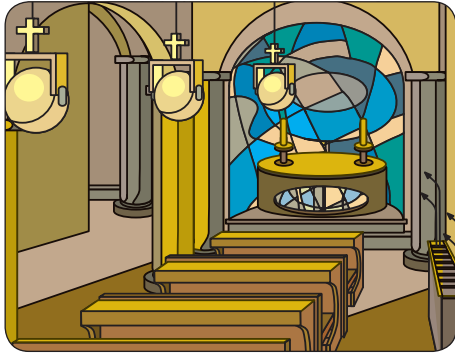

### Example of installation

*As shown in the diagrams, one of the possible applications is to mount the DT2 two-channel digital time switch inside the power supply circuit of a church, where in the days when no service is performed only the heating system is activated (programmed on one of the two channels) at a preset time, while on Sundays and when services are performed the lighting system is also switched on (through a program on the second channel). According to the controlled system power, the activation is performed by an ESB contactor.*

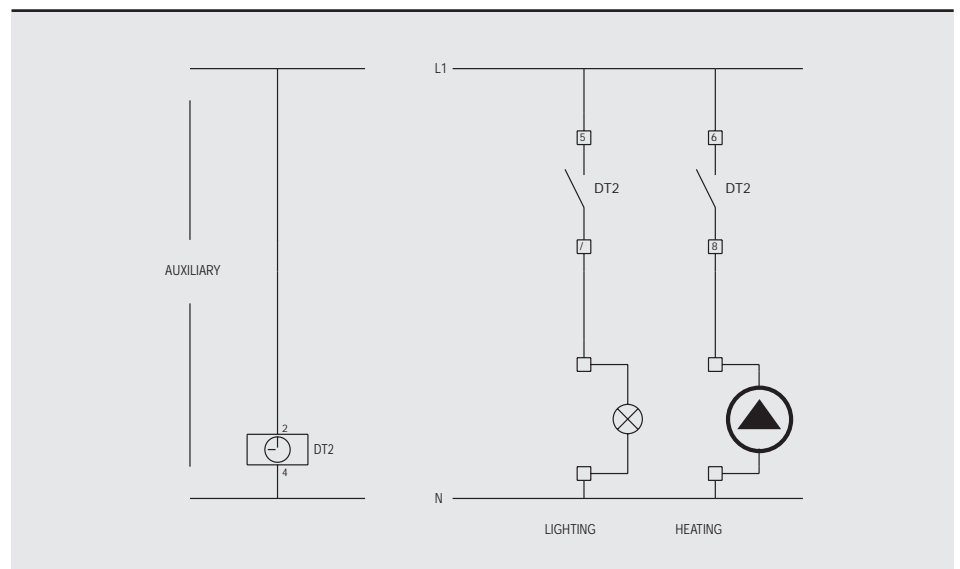
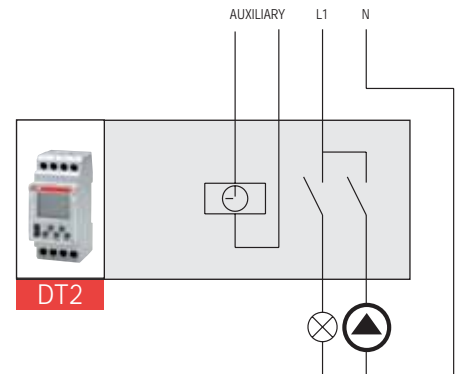



# Technical characteristics and order codes

## Technical characteristics

Rated voltage	[V]	230 AC $\pm$ 15% 12-24 AC/DC
Switching capacity		
- resistive load	[A]	16 ( $\cos\varphi=1$ )
- inductive load	[A]	10 ( $\cos\varphi=0.6$ )
Contact type		1 CO for DT1, DT1-K, DT1-IK, DT1-IK/24, DT1-IK/DCF 2 CO for DT2, DT2-K, DT2-IK
Frequency	[Hz]	50/60
Time base		quartz
Program steps	[n°]	56
No. of channels	[n°]	1 for DT1, DT1-K, DT1-IK, DT1-IK/24, DT1-IK/DCF 2 for DT2, DT2-K, DT2-IK
Minimum time between two steps	[min.]	1
Impulse/cycle output	[s/min.]	from 1s to 30 min
Operating accuracy	[s]	$\pm$ 1s/day
Protection degree	[IP]	20
Power reserve		5 years (lithium battery)
Operating temperature	[°C]	-5...+45
Power consumption	[VA]	6 for DT1, DT1-K, DT1-IK, DT2, DT2-K, DT2-IK 0.5 for DT1-IK/DCF 0.8 for DT1-IK/24
Terminal size for cable		loss-proof screw
Installation		on DIN rail
Modules	[n°]	2

## Order codes

CODE	TYPE	DESCRIPTION
2CSM204255R0611	DT1	weekly digital time switch, 1 CO contact, 5 years power reserve, 2 modules
2CSM204265R0611	DT1-K	weekly digital time switch, 1 CO contact, 5 years power reserve, programming key, 2 modules
2CSM204275R0611	DT1-IK	weekly digital time switch, 1 CO contact, random/holiday/waiver mode, pulse function, programming key, backlit display, 5 years power reserve, 2 modules
2CSM204285R0611	DT1-IK/24	weekly digital time switch, one 24 V CO contact, random/holiday mode, pulse function, programming key, 5 years power reserve, 2 modules
2CSM204295R0611	DT1-IK/DCF	weekly digital time switch, 1 CO contact, random/holiday mode, pulse function, programming key, radiosynchronized, antenna DCF, 5 years power reserve, 2 modules
2CSM204305R0611	DT2	weekly digital time switch, 2 CO contacts, 5 years power reserve, 2 modules
2CSM204315R0611	DT2-K	weekly digital time switch, 2 CO contacts, 5 years power reserve, programming key, 2 modules
2CSM204325R0611	DT2-IK	weekly digital time switch, 2 CO contacts, random/holiday/waiver mode, pulse function, programming key, backlit display, 5 years power reserve, 2 modules
2CSM204335R0611	DT-VK	programming key for DT digital time switches
2CSM204615R0611	DT-LK	locking key for DT digital time switches
2CSM204345R0611	DT-SW	software HANDYTIMER and software plug-in adaptor with USB cable
2CSM204355R0611	DT-DCF	antenna DCF77 for DT1-IK/DCF

## Connection diagrams

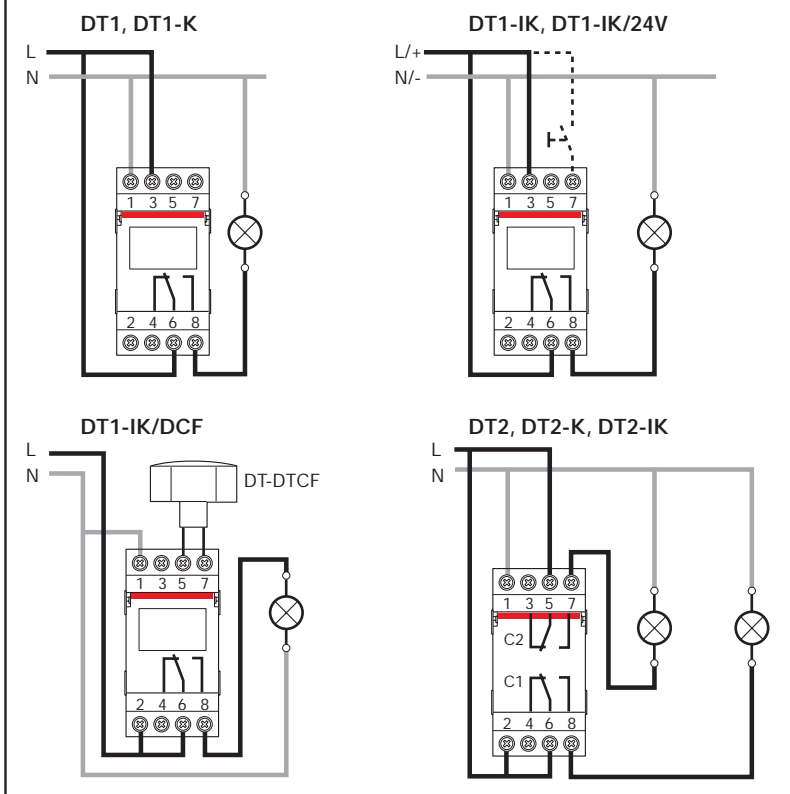

## Overall dimensions

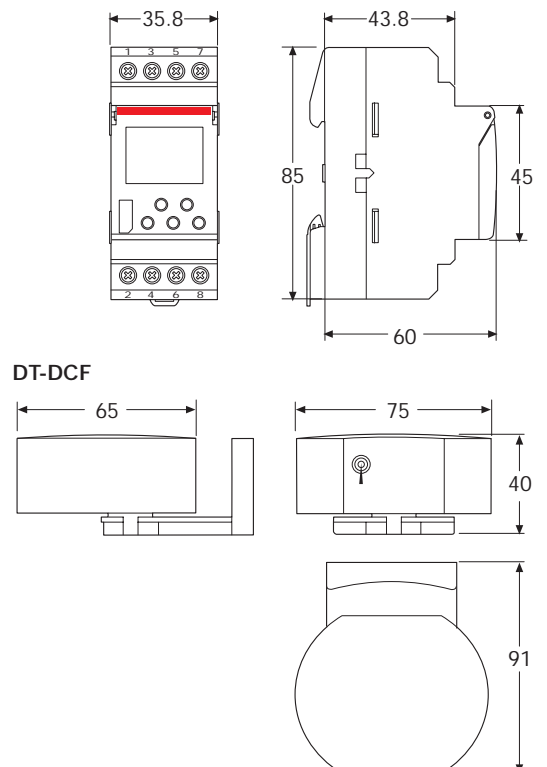

# TW twilight switches

ABB Sace's twilight switches turn on the lighting in an installation when the daylight level measured by a special sensor falls below a set threshold. They are especially useful in places accessible to the public (parks, car parks, entrance halls, courtyards, etc.), because their features enable power savings. In addition the switching delay also prevents unnecessary ON/OFF switching in case of sudden changes in the daylight level (e.g. lightning, vehicles and so on).

The TW1 switch, with instructions printed on one side, is equipped with 2 warning LEDs to indicate the brightness range and the contact's status and is sold together with the sensor, also available separately, preset at 10 Lux (the average value for street lighting). Its features also make it suitable for public lighting, monuments etc.

The TW2/10K switch has three different brightness ranges (2:100, 2:1,000, 2:10,000), ideal for day-time applications when the level of light is very high. Factory-preset at 10 Lux, the switch has 2 warning LEDs to indicate the threshold chosen and the contact's status.

The TW1-D switch, with integrated digital time, can be used to switch lights ON/OFF according to a defined Lux value and to a given time.



This is particularly useful for saving energy consumption (e.g. shop windows and signs).

The TWA-1 and TWA-2 twilight astronomical switches, respectively with 1 and 2 channels, automatically control lighting systems according to the times when the sun rises and sets. Programming is carried out by defining the

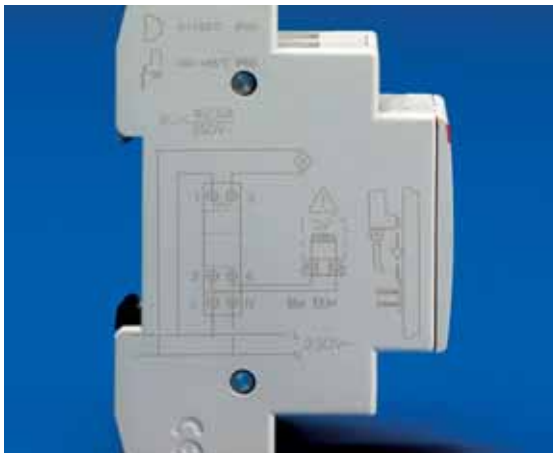



longitude and latitude parameters of the geographical area where the switch is mounted. These devices are particularly suitable when a twilight switch with external sensor is potentially subject to damage caused by atmospheric and light pollution and by vandalism.

The TWP pole mounting switch equipped with an integrated photo-sensor preset at 10 Lux is the ideal solution for controlling external lighting systems such as street lamps. They are supplied with water-proof cable glands, user instructions printed on the back of the product and a pull-out sensor that allows fast, safe and error-proof maintenance operations.

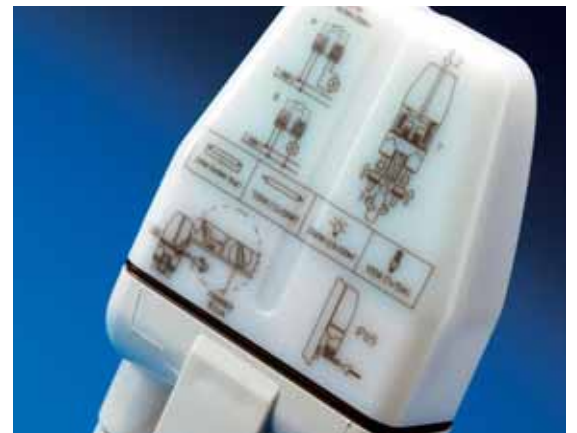

# Application example

## TW1-D twilight switches

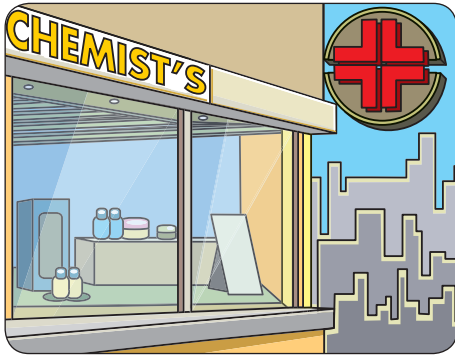

### Operating principle

The diagram shows the installation of the TW1-D twilight switches in the lighting system of a chemist's. When the external light decreases below a certain level (i.e. shop opening during evening hours), the device controls the lighting of windows and sign. When the chemist's is opened during the night, the switch-on of all lights is set through time programming.

### Application environments

The installation of TW1-D twilight switches is suitable for any environment and situation needing the rationalization of power consumption (shops, offices and public passage areas, parking, parks, etc.).

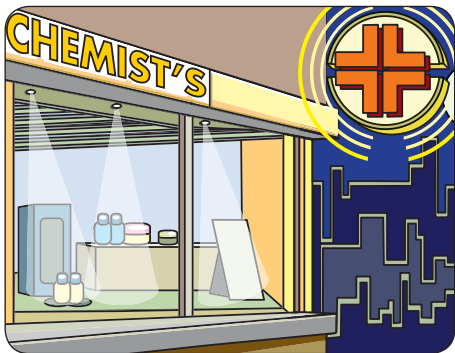
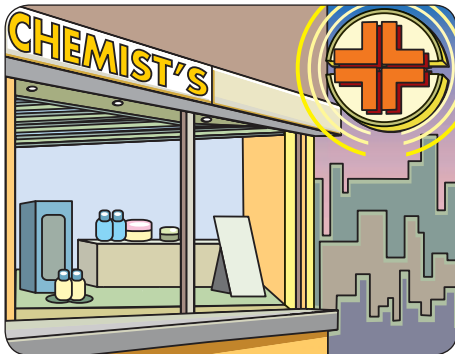

### Example of installation

*As shown in the diagrams, one of the possible applications is the installation of the TW1-D twilight switches in the lighting system of a chemist's. When the external light decreases below a certain level (i.e. shop opening during evening hours), the twilight switch controls the lighting of windows, sign and cross sign. The last one can have an intermittent switch-on/off because of E 234 TI time delay relay installation. When the chemist's is opened during the night, the switch-on of all lights (using the twilight switch) is set through date and time programming using time switch. When the chemist's is closed, the time switch programming switches off the windows and cross sign lights independently from twilight switch (sign ON).*

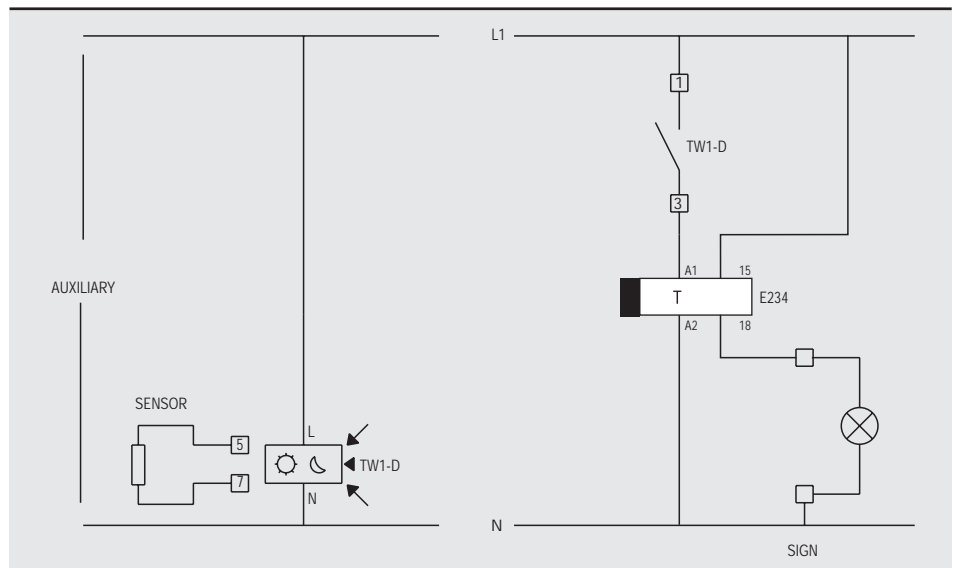
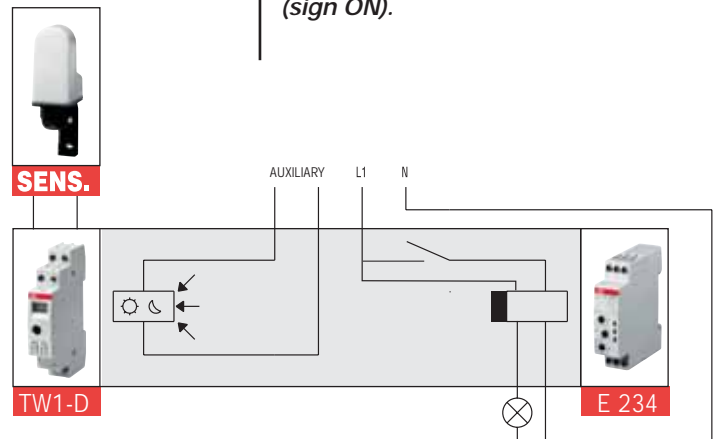



# Application example

## TWA-1/TWA-2 twilight switches



### Operating principle

Installation of a twilight astronomical switch in a system is particularly useful in places and situations where light sources or other environmental conditions may cause changes in the Lux level.

In these cases, TWA-1 and TWA-2 enable control of the lighting system depending on the time when the sun rises and sets, based on the geographic location where they are installed.

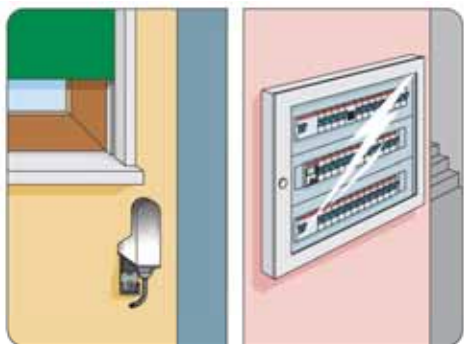

### Application environments

The TWA-1 and TWA-2 twilight astronomical switches are particularly suitable for use in applications where the operation of a twilight switch with external sensor is potentially subject to alteration or damage from external agents (e.g. smog, overexposure to light, vandalism etc.).



### Example of installation

*One cause of reductions in the level of ambient light is atmospheric smog. Particle deposits on the external sensor of a traditional twilight switch can over time compromise its operation, preventing the activation of the lighting systems controlled. As illustrated in the diagrams, it is possible to counter this type of problem by installing a TWA twilight astronomical switch, which controls the lighting based on the ambient light level calculated from the preset longitude and latitude parameters.*

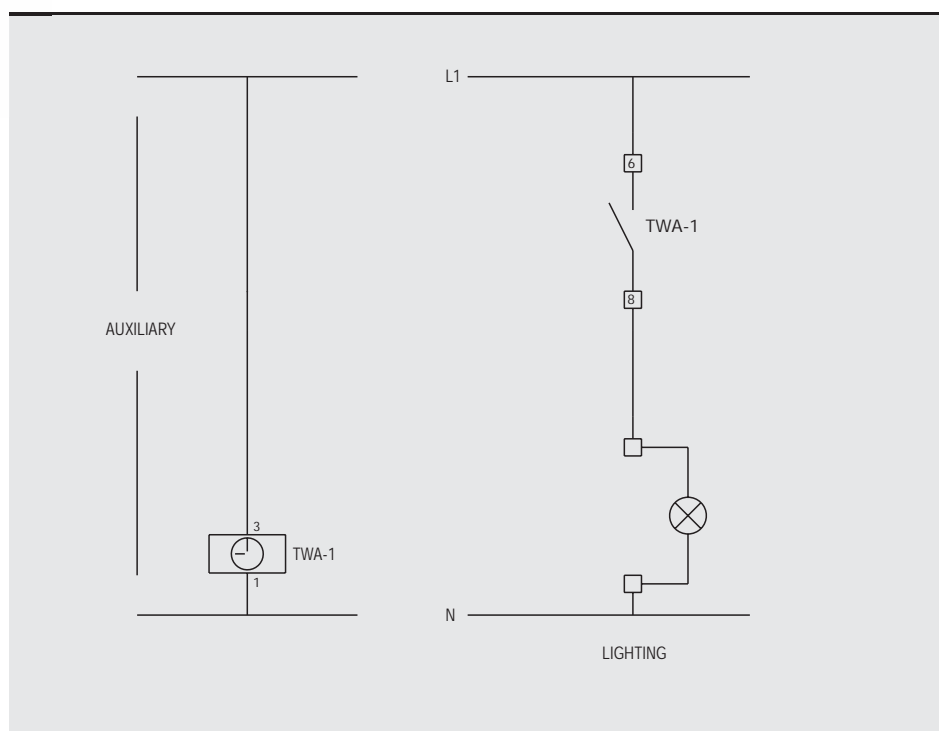
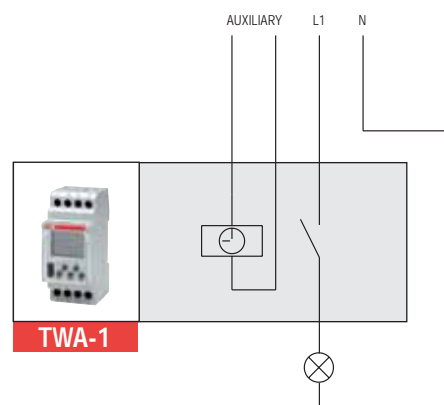

# Technical characteristics and order codes

## Technical characteristics

Rated voltage	[V]	230 AC
Switching capacity - resistive load - inductive load	[A]	16 (cosφ=1)
		10 (cosφ=0.6) for TWA-1, TWA-2
		3 (cosφ=0,6)
Contact type		1 NO for TW1, TW1-D
		1 NO polarised for TWP
		1 CO for TW2/10K, TWA-1
		2 CO for TWA-2
Frequency	[Hz]	50/60
ON-OFF programs		1 OFF for TW1-D
Program steps	[n°]	56 for TWA-1, TWA-2
No. of channels	[n°]	1 for TWA-1
		2 for TWA-2
Minimum time between two steps	[min.]	1 for TWA-1, TWA-2
Operating accuracy		± 2s/day for TW1-D
		± 1.5s/day for TWA-1, TWA-2
Brightness range	[Lux]	2:100 for TW1, TW2/10K
		2:200 for TW1-D, TWP
		2:1.000 for TW2/10K
		2:10.000 for TW2/10K
Protection degree		IP 20 switch
		IP 65 sensor and TWP
Power reserve		5 years (lithium battery) for TWA-1, TWA-2
Operating temperature	[°C]	0...+50 for TW1-D
		0...+55 for TW1, TW2/10K
		-10...+55 for TWA-1, TWA-2
		-30...+50 for TWP
		-30...+65 sensor
Power consumption	[VA]	7.5 for TWP
		6 for TWA-1, TWA-2
		4.5 for TW1
		3 for TW1-D
		2.5 for TW2/10K
Maximum wiring length	[m]	100
Terminal size for cable		loss-proof screw
Mounting		on DIN rail
		pole-mounted for TWP
Modules	[n°]	1 for TW1, TW1-D
		2 for TW2/10K, TWA-1, TWA-2
Standards		EN 60669-1; EN 60669-2-1

## Order codes

CODE	TYPE	DESCRIPTION
2CSM204365R1341	TWA-1	weekly twilight astronomical switch, with remote control, 1 CO contact, 5 years power reserve, 2 modules
2CSM204375R1341	TWA-2	weekly twilight astronomical switch, with remote control, 2 CO contacts, 5 years power reserve, 2 modules
2CSM204135R1341	TW1	twilight switch, 1 NO contact, adjustable 2-100LUX, IP20 and external IP65 sensor, 1 module
2CSM204145R1341	TW2/10K	twilight switch, 1 CO contact, adjustable 2-10.000LUX, IP20 and external IP65 sensor, 2 modules
2CSM204155R1341	TW1/D	twilight switch with digital time integrated, 1 NO contact, adjustable 2-200LUX, IP20 and external IP65 sensor, 1 module
2CSM204165R1341	TWP	pole-mounted twilight switch, 1 NO polarized contact, adjustable 2-200LUX, IP65
2CSM204185R1341	LS-65	spare sensor for TWP
2CSM204195R1341	LS-SP	spare sensor for modular TW twilight switches

## Connection diagrams

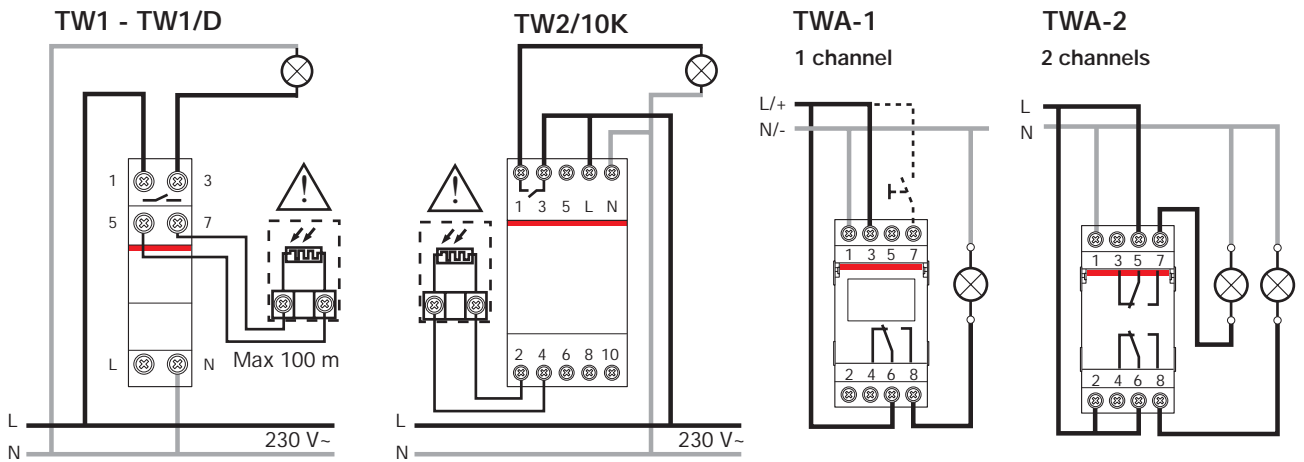

## TWP

230 V~ -30T60

—16 (3)A / 250 V~

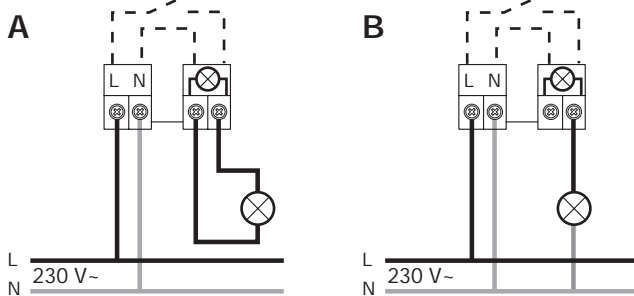

## Overall dimensions

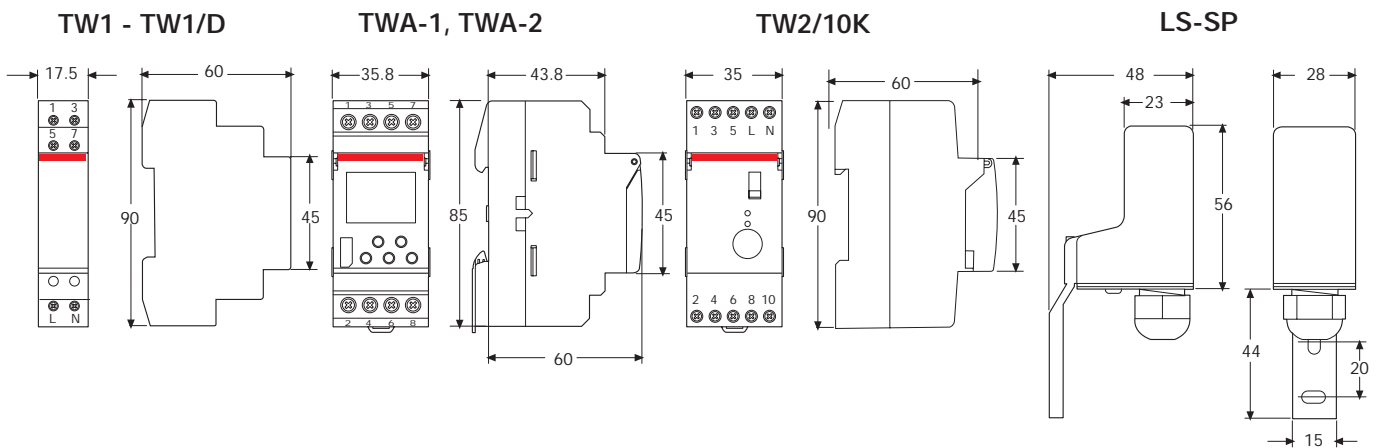



---

**ABB SACE S.p.A**

An ABB Group company

*Modular Devices*

Viale dell'Industria, 18

20010 Vittuone (MI), Italy

Tel.: +39 02.9034.1 - Telefax: +39 02.9034.7609

<http://www.abb.com>

Due to possible developments of standards as well as of materials, the characteristics and dimensions specified in the present document may only be considered binding after confirmation by ABB SACE.