

Taking advantage of the 4-gap balanced armature mechanism, S relays have met a number of relay needs and earned a reputation for the characteristics that they provide. Building on the same structure, the SP relay was introduced as a high-sensitivity power relay to provide nominal operating power of 300 mW and minimum operating power of 150 mW (single side stable and 2 coil latching types). Even so, with the nominal switching capacity for the 2 Form C at 15 A, and for the 4 Form C at 10 A, high-capacity switching is possible with small input. Moreover, taking full advantage of the excellence of the 4-gap balanced armature mechanism, we have realized a small, slim form factor that also has superior resistance to vibration and shock. This power relay is often chosen for NC machines and electrical power remote monitoring control panels, and for power supplies used in computers and other equipment. The SP also often provides power control for high-end business and industrial equipment.

FEATURES

1. Small, slim form factor

Facilitating the form factor reduction of devices, the overall height of the relay package is less than half that of our HP relay.

2. High sensitivity

The high-efficiency polarized electromagnetic mechanism in conjunction with our exclusive spring alignment method achieves levels of sensitivity higher than relays that have been available up to now. For both the 2 Form C and 4 Form C single side stable and 2 coil latching types, the 150 mW minimum operating power level allows direct driving by transistor or chip controllers.

3. High reliability and long life

With a structure that ensures almost perfectly complete twin contact and minimal contact bounce, you get greater reliability than has so far been provided by power relays.

4. Latching types also available

1 coil latching and 2 coil latching types are available. In cases where it was formerly unavoidable to use plural relays for large power memory, you can now use a single SP relay.

5. Strong resistance to vibration and shock

Our balanced armature technology well withstands vibration and shocks. It provides strong resistance to vibration and shock.

RoHS Directive compatibility information
<http://www.mew.co.jp/ac/e/environment/>

ORDERING INFORMATION

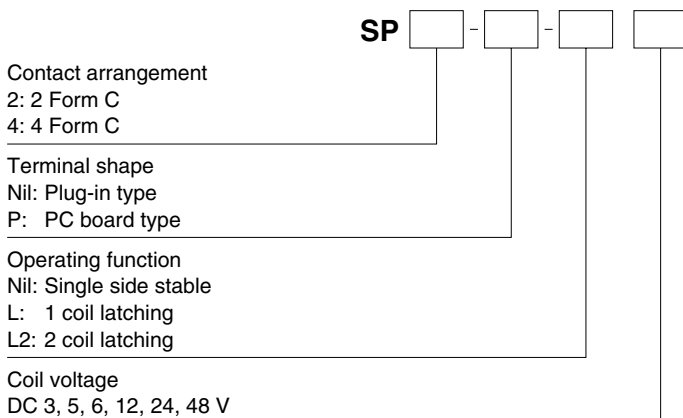

Notes: 1. PC board type and 1 coil latching type are manufactured by lot upon receipt of order.
2. UL/CSA and TÜV approved type is standard.

TYPES

Contact arrangement	Nominal coil voltage	Single side stable	2 coil latching
		Part No.	Part No.
2 Form C	3V DC	SP2-DC3V	SP2-L2-DC3V
	5V DC	SP2-DC5V	SP2-L2-DC5V
	6V DC	SP2-DC6V	SP2-L2-DC6V
	12V DC	SP2-DC12V	SP2-L2-DC12V
	24V DC	SP2-DC24V	SP2-L2-DC24V
	48V DC	SP2-DC48V	SP2-L2-DC48V
4 Form C	3V DC	SP4-DC3V	SP4-L2-DC3V
	5V DC	SP4-DC5V	SP4-L2-DC5V
	6V DC	SP4-DC6V	SP4-L2-DC6V
	12V DC	SP4-DC12V	SP4-L2-DC12V
	24V DC	SP4-DC24V	SP4-L2-DC24V
	48V DC	SP4-DC48V	SP4-L2-DC48V

Standard packing (2 Form C): Tube: 20 pcs.; Case: 200 pcs.

Standard packing (4 Form C): Tube: 10 pcs.; Case: 100 pcs.

Note: PC board type and 1 coil latching type are manufactured by lot upon receipt of order.

RATING

1. Coil data

1) Single side stable

Nominal coil voltage	Pick-up voltage (at 20°C 68°F)	Drop-out voltage (at 20°C 68°F)	Nominal operating current [±10%] (at 20°C 68°F)	Coil resistance [±10%] (at 20°C 68°F)	Nominal operating power	Max. allowable voltage
3V DC	70%V or less of nominal voltage (Initial)	10%V or more of nominal voltage (Initial)	100mA	30Ω	300mW	150%V of nominal voltage
5V DC			60.2mA	83Ω		
6V DC			50mA	120Ω		
12V DC			25mA	480Ω		
24V DC			12.5mA	1,920Ω		
48V DC			6.2mA	7,700Ω		

2) 2 coil latching

Nominal coil voltage	Set voltage (at 20°C 68°F)	Reset voltage (at 20°C 68°F)	Nominal operating current [±10%] (at 20°C 68°F)		Coil resistance [±10%] (at 20°C 68°F)		Nominal operating power		Max. allowable voltage
			Set coil	Reset coil	Set coil	Reset coil	Set coil	Reset coil	
3V DC	70%V or less of nominal voltage (Initial)	70%V or less of nominal voltage (Initial)	100mA	100mA	30Ω	30Ω	300mW	300mW	150%V of nominal voltage
5V DC			60.2mA	60.2mA	83Ω	83Ω			
6V DC			50mA	50mA	120Ω	120Ω			
12V DC			25mA	25mA	480Ω	480Ω			
24V DC			12.5mA	12.5mA	1,920Ω	1,920Ω			
48V DC			6.2mA	6.2mA	7,680Ω	7,680Ω			

2. Specifications

Characteristics	Item	Specifications	
Contact	Initial contact pressure	2 Form C: Approx. 0.392 N (40 g 1.41 oz), 4 Form C: Approx. 0.196 N (20 g 0.71 oz)	
	Arrangement	2 Form C, 4 Form C	
	Initial contact resistance, max.	Max. 30 mΩ (By voltage drop 6 V DC 1A)	
	Contact material	Stationary contact: Au flashed AgSnO ₂ type, Movable contact: AgSnO ₂ type	
Rating	Nominal switching capacity (resistive load)	2 Form C: 15 A 250 V AC, 4 Form C: 10 A 250 V AC	
	Max. switching power (resistive load)	2 Form C: 3,750 VA, 300 W, 4 Form C: 2,500 VA, 300 W	
	Max. switching voltage	2 Form C, 4 Form C: 250 V AC, 30 V DC (48V DC: Max. 2A)	
	Max. switching current	2 Form C: 15 A (AC) 10 A (DC), 4 Form C: 10 A	
	Minimum operating power	150mW (Single side stable, 2 coil latching)	
	Nominal operating power	300mW (Single side stable, 2 coil latching)	
	Min. switching capacity (Reference value)*1	100 mA 5V DC	
Electrical characteristics	Insulation resistance (Initial) (25°C, 50% relative humidity)	Min. 1,000MΩ (at 500V DC) Measurement at same location as "Initial breakdown voltage" section.	
	Breakdown voltage (Initial)	Between open contacts	1,500 Vrms for 1 min. (Detection current: 10 mA)
		Between contact and coil	3,000 Vrms for 1 min. (Detection current: 10 mA)
		Between contact sets	3,000 Vrms for 1 min. (Detection current: 10 mA)
	Operate time [Set time] (at 20°C 68°F)	Max. 30 ms [Max. 30 ms] (Nominal voltage applied to the coil, excluding contact bounce time.)	
	Release time [Reset time] (at 20°C 68°F)	Max. 20 ms [Max. 30 ms] (Nominal voltage applied to the coil, excluding contact bounce time.) (without diode)	
Temperature rise (at 20°C 68°F)	Max. 40°C (By resistive method, nominal voltage applied to the coil; nominal switching capacity.)		
Mechanical characteristics	Shock resistance	Functional	Min. 392 m/s ² (Half-wave pulse of sine wave: 11 ms; detection time: 10μs.)
		Destructive	Min. 980 m/s ² (Half-wave pulse of sine wave: 6 ms.)
	Vibration resistance	Functional	10 to 55 Hz at double amplitude of 3 mm (Detection time: 10μs.)
		Destructive	10 to 55 Hz at double amplitude of 3 mm
Expected life	Mechanical	Min. 5×10 ⁷ (at 180 cpm)	
	Electrical (resistive load)	2 Form C: Min. 10 ⁵ (15 A 250 V AC [at 20 cpm]), Min. 10 ⁵ (10 A 30 V DC [at 20 cpm]) 4 Form C: Min. 10 ⁵ (15 A 250 V AC [at 20 cpm]), Min. 10 ⁵ (10 A 30 V DC [at 20 cpm])	
Conditions	Conditions for operation, transport and storage*2	Ambient temperature: -50°C to +60°C -58°F to +140°F; Humidity: 5 to 85% R.H. (Not freezing and condensing at low temperature)	
	Max. operating speed	20 cpm (at rated load)	
Unit weight		2 Form C: 50 g 1.76 oz; 4 Form C: 65 g 2.29 oz	

Notes: *1 This value can change due to the switching frequency, environmental conditions, and desired reliability level, therefore it is recommended to check this with the actual load.

*2 Refer to 6. Conditions for operation, transport and storage mentioned in AMBIENT ENVIRONMENT.

REFERENCE DATA

Operate and release time (Single side stable)
SP2

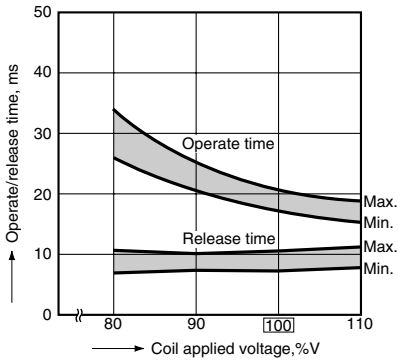

SP4

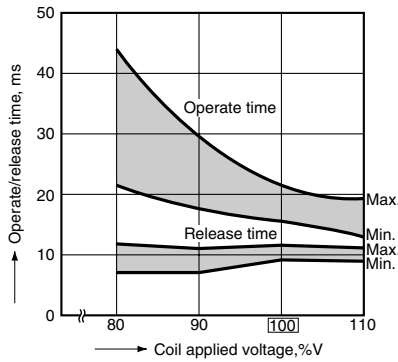

Coil temperature rise
Tested sample: SP2-DC24V
Ambient temperature: 20 to 22°C 68 to 72°F

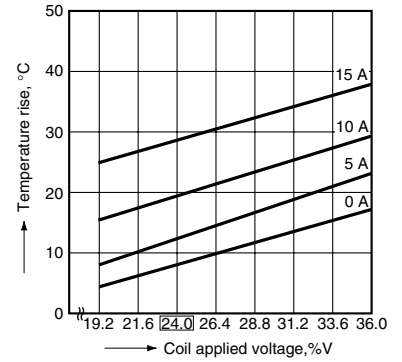

Tested sample: SP4-DC24V
Ambient temperature: 27 to 29°C 81 to 84°F

Electrical life
(SP2, 15 A 250 V AC resistive load)

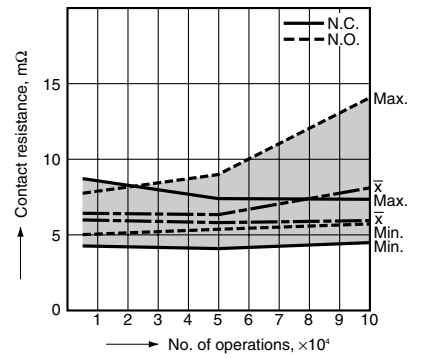
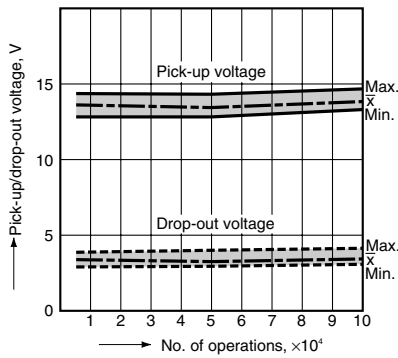
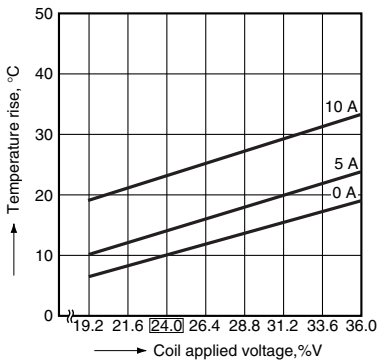

Electrical life
(SP4, 10 A 250 V AC resistive load)

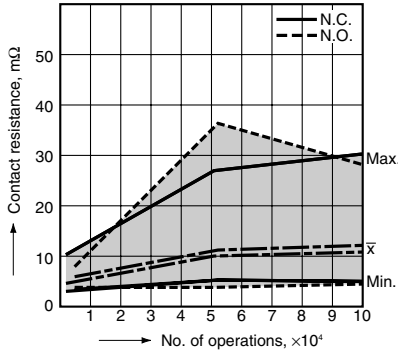
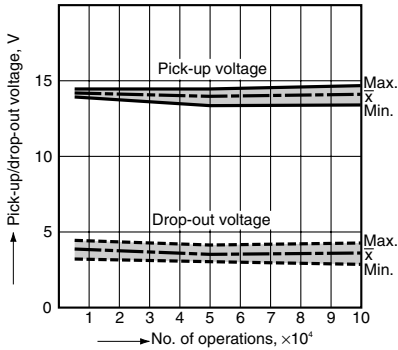

DIMENSIONS (Unit: mm inch)

2 Form C

Plug-in terminal

External dimensions

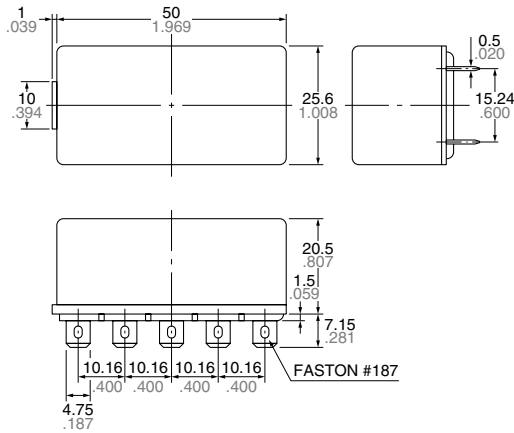

General tolerance: $\pm 0.3 \pm .012$

PC board type

External dimensions

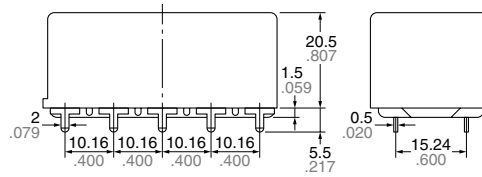

General tolerance: $\pm 0.3 \pm .012$

PC board pattern (Bottom view)

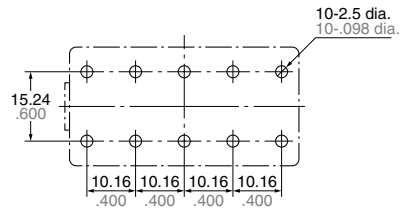

Tolerance: $\pm 0.1 \pm .004$

Schematic (Bottom view)

Single side stable

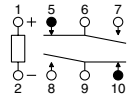

(Deenergized condition)

2 coil latching

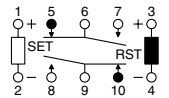

(Reset condition)

Diagram shows the "reset" position when terminals 3 and 4 are energized. Energize terminals 1 and 2 to transfer contacts.

4 Form C

Plug-in terminal

External dimensions

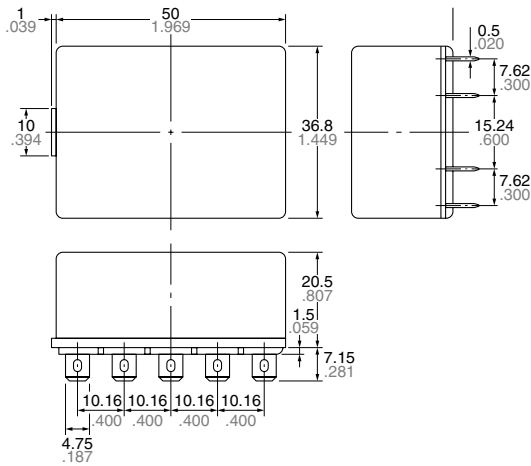

General tolerance: $\pm 0.3 \pm .012$

PC board type

External dimensions

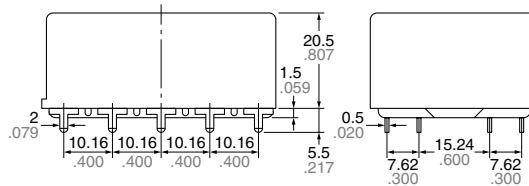

General tolerance: $\pm 0.3 \pm .012$

PC board pattern (Bottom view)

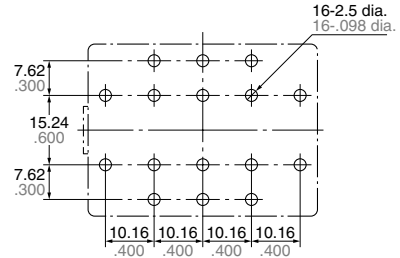

Tolerance: $\pm 0.1 \pm .004$

Schematic (Bottom view)

Single side stable

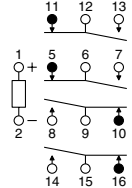

(Deenergized condition)

2 coil latching

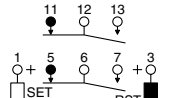

(Reset condition)

Diagram shows the "reset" position when terminals 3 and 4 are energized. Energize terminals 1 and 2 to transfer contacts.

For Cautions for Use, see Relay Technical Information.

DIMENSIONS (Unit: mm inch)

SP2-Terminal socket

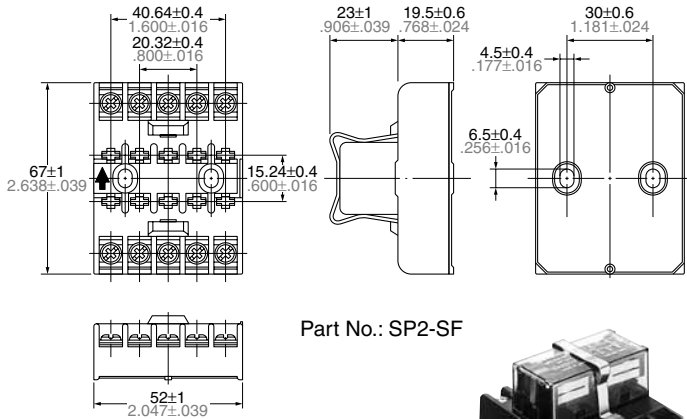

Part No.: SP2-SF



SP4-Terminal socket

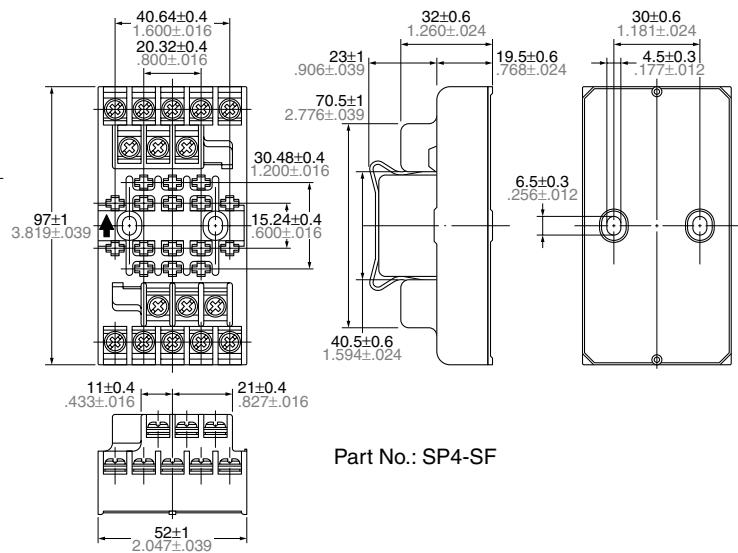

Part No.: SP4-SF

RoHS Directive compatibility information
<http://www.mew.co.jp/ac/e/environment/>

Note: Terminal number marking is on the socket body. Please refer together with the SP relay schematic.

General tolerance: ±0.5 ±0.020

Mounting hole diagram

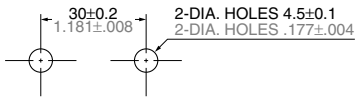

Notes:

- (1) Mounting screws and the fastening bracket are included in the package.
- (2) Mount the relay with the proper mounting direction — i.e. with the direction of the **M** mark on top of the relay case matching the direction of the **M** mark on the terminal block. (The **↑** direction of the terminal block is the upward direction of the relay.)

Fastening bracket mounting and removal

1. Mounting

Insert the A part of the fastening bracket into the mounting groove of the terminal block, and then fit the B part into groove, while pressing with the tip of a minus screwdriver.

2. Removal

Slide the B part of the fastening bracket from the groove in the terminal block, while pressing with the tip of a minus screwdriver. While the bracket is in this position, keep pressing the C part of the bracket to the relay side with your finger, and lift up to the left side and remove from the groove, as in the diagram at right.

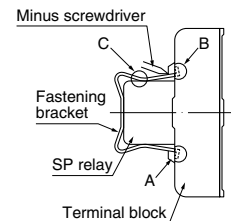

DIMENSIONS (Unit: mm inch)

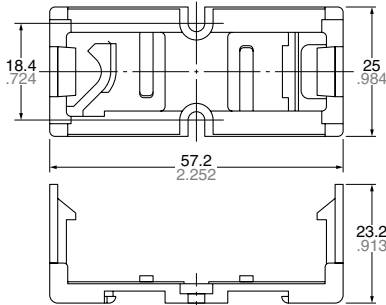

Mounting hole diagram

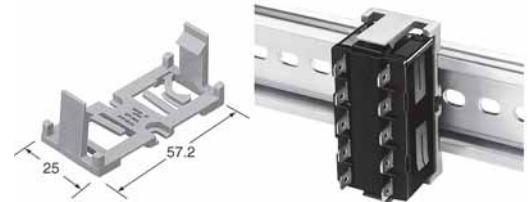
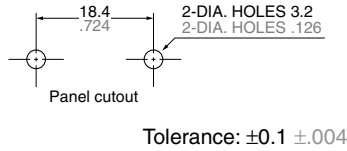

Part No.: SP-MA

Direct chassis mounting possible, and applicable to DIN rail.

Use method

- Both the SP relay 2 Form C and 4 Form C can be mounted to the mounting slats.
 - Use the mounting slats either by attaching them directly to the chassis, or by mounting with a DIN rail.
 - (A) When attaching directly to chassis Use two M3 screws.
 - For the mounting pitch, refer to the specification diagram.
 - (B) When mounting on a DIN rail Use a 35mm 1.378inch wide DIN rail (DIN46277).
- The mounting method should be as indicated in the diagram at right.

Method for mounting on DIN rail

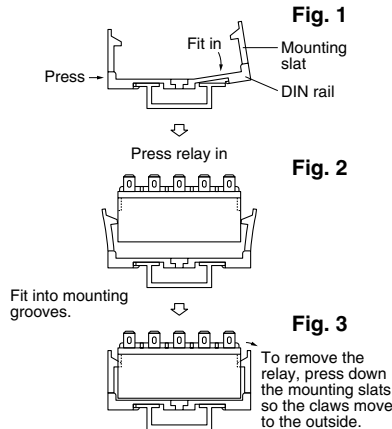

- First fit the arc shaped claw of the mounting slat into the DIN rail.
- Press on the side as shown in the diagram below.
- Fit in the claw part on the opposite side.

Precautions for use

When mounting to a DIN rail, use a commercially available fastening bracket if there is a need to stop sliding of the mounting slat in the rail direction.