

# ET-190-1010-1212

## Peltier cooler module

### Data sheet

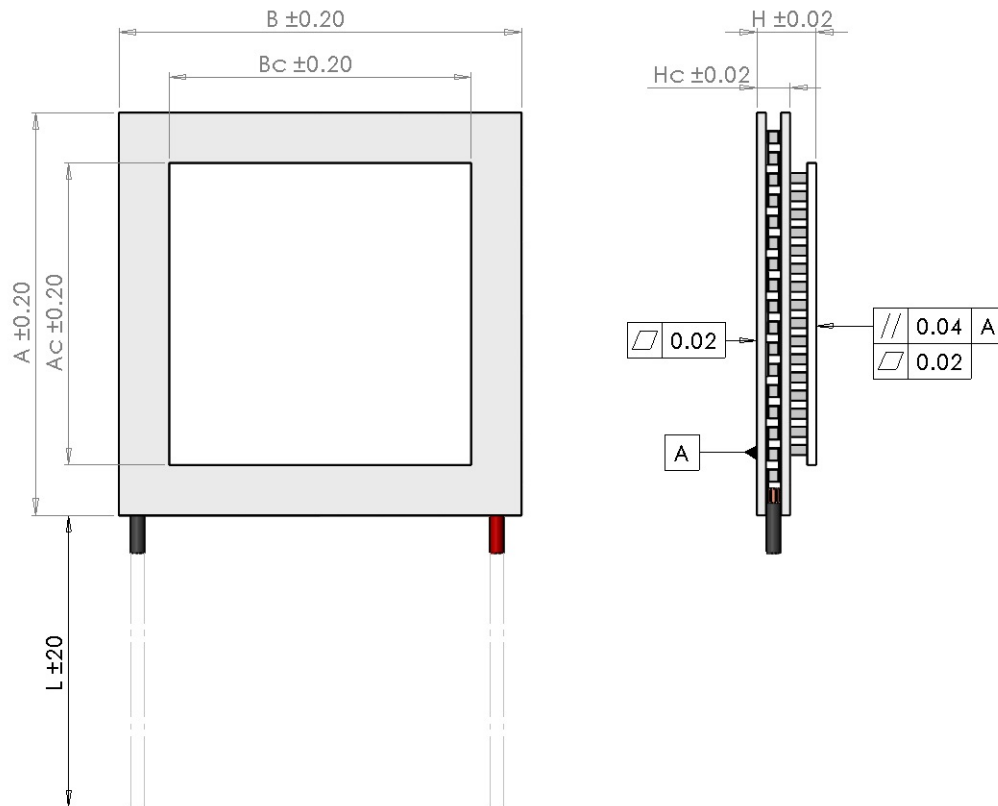

$I_{max}$	[A]	2.8
$V_{max}$	[Vdc]	15.7
$P_c \text{ max}$	[W]	16.4
$\Delta T_{max}$	[°C]	85
A	[mm]	30
AI	[mm]	30
B	[mm]	30
H	[mm]	6.5
L	[mm]	100
Wire	AWG	n/a

- (At hot side temperature  $T_h = 25^\circ\text{C} / 298\text{K}$ , under dry  $\text{N}_2$ )
- $P_c \text{ max}$  = Cooling power at  $\Delta T = 0$  and  $I = I_{max}$
- $\Delta T_{max}$  = Temperature difference at  $I = I_{max}$  and  $P_c = 0$
- Max hot side temperature  $T_h = 90^\circ\text{C}$  for best long term performance
- Max mounting pressure: 1.5MPa
- Wires: UL-style 1569, 105°C (Unstripped)



# ET-190-1010-1212

## Peltier cooler module

Data sheet - At hot side temperature 27°C

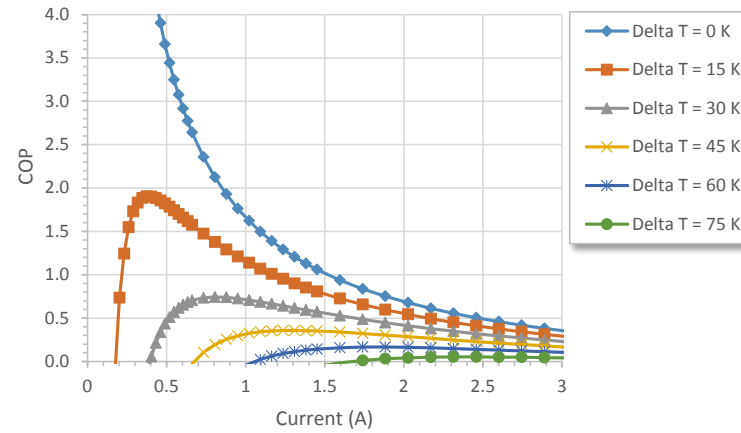
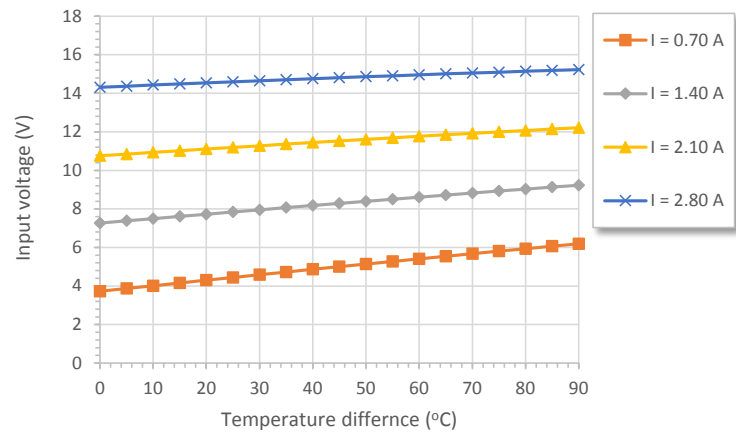
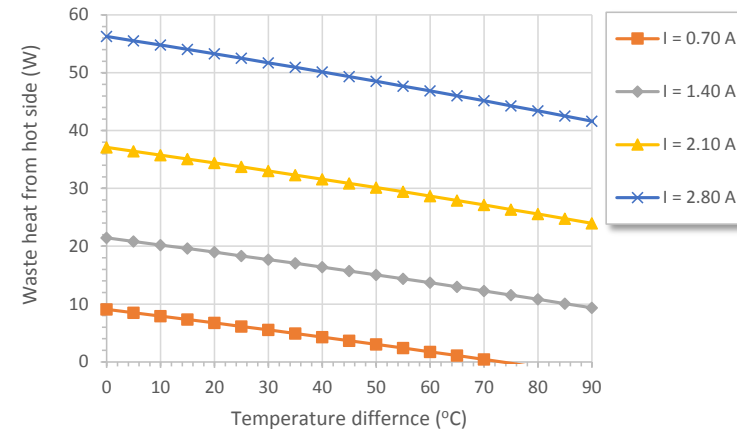
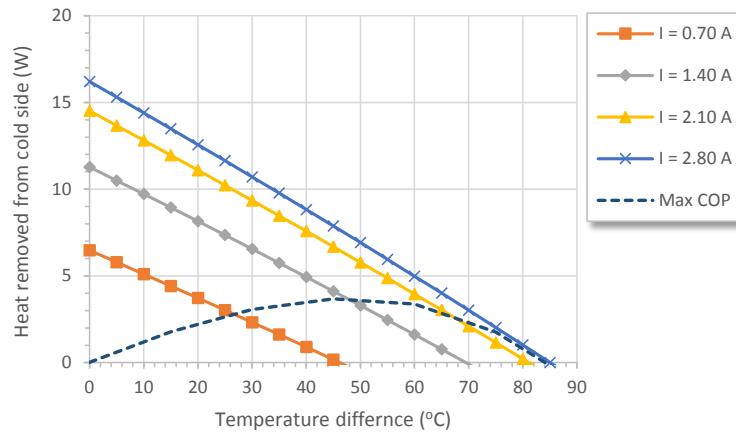

\*Note - Waste heat = Heat out of hot side



# ET-190-1010-1212

## Peltier cooler module

### Data sheet - At hot side temperature 50°C

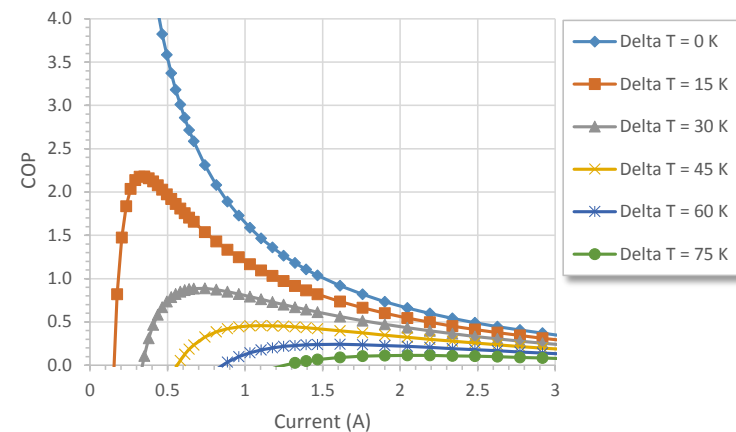
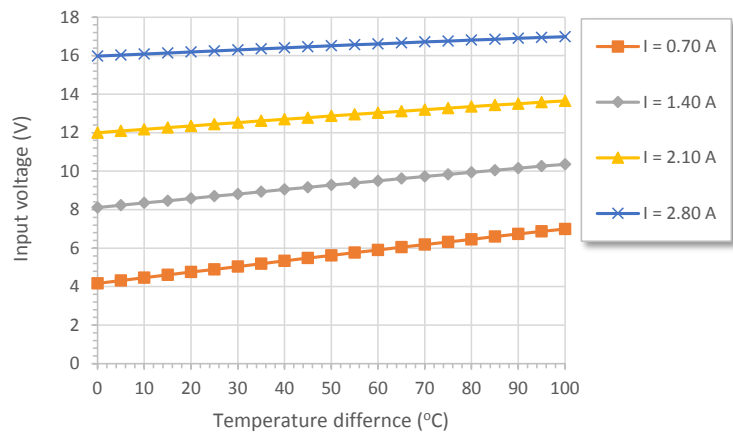
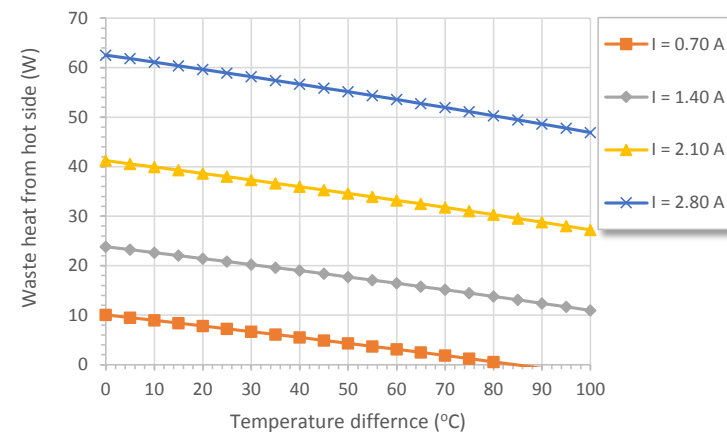
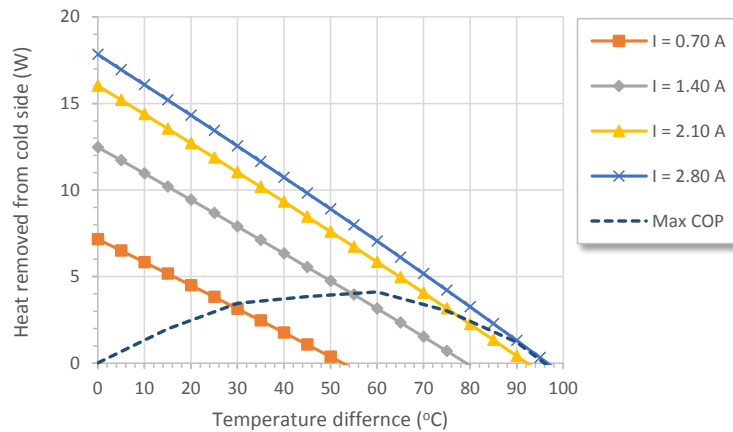

\*Note - Waste heat = Heat out of hot side



# ET-190-1010-1212

## Peltier cooler module

### Data sheet - At hot side temperature 75°C

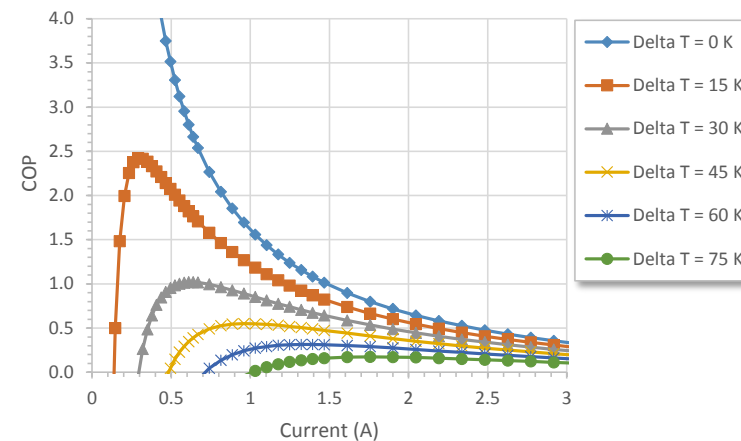
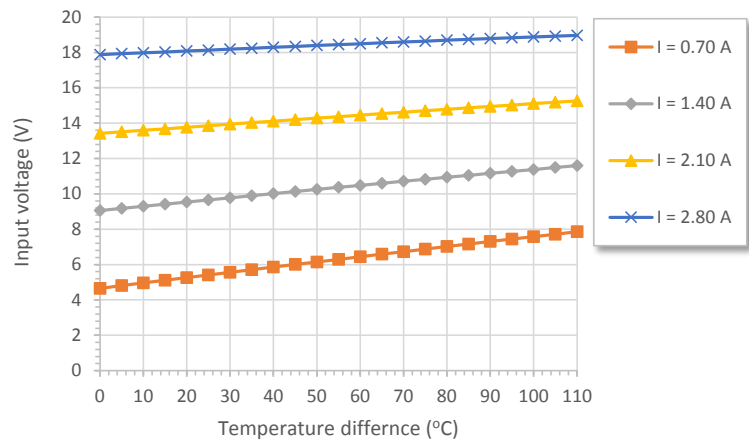
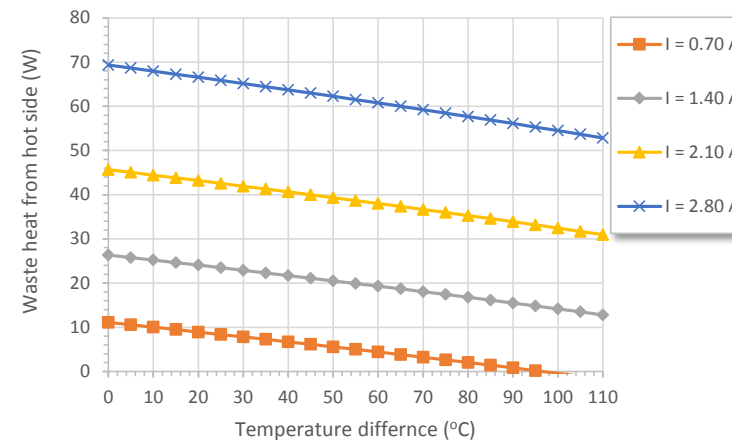
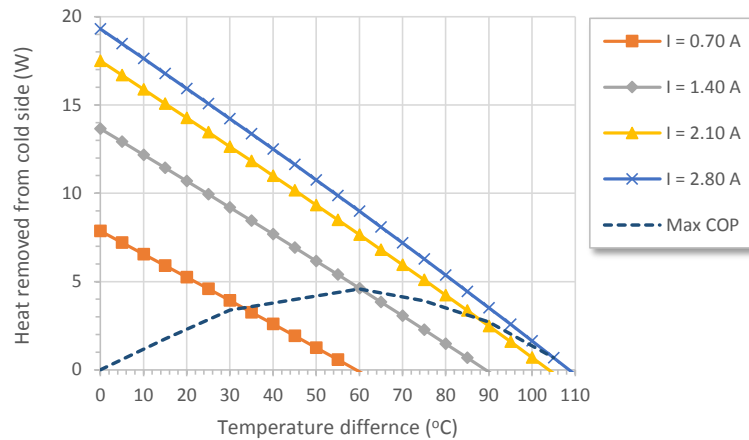

\*Note - Waste heat = Heat out of hot side

