



### Features

- Using a dedicated IC, the operation time variance is  $\pm 0.5\%$ .
- Using the slide, time range switching is easy. Moreover, the scale numbers on the dial and time units can be switched automatically.

Button position				
Type				
10M type	0.05S to 1.0S	0.5S to 10S	0.05M to 1.0M	0.5M to 10M
30M type	0.15S to 3.0S	1.5S to 30S	0.15M to 3.0M	1.5M to 30M
10H type	0.05M to 1.0M	0.5M to 10M	0.05H to 1.0H	0.5H to 10H
30H type	0.15M to 3.0M	1.5M to 30M	0.15H to 3.0H	1.5H to 30H

- You can use for embedding if you use together with the appropriate flush type mounting frame designed for that purpose (sold separately).

**Time selectable**

## Product types

Product name	Operating voltage	10M type	30M type	10H type	30H type
		Part No.	Part No.	Part No.	Part No.
PMH timer	100 to 120 V AC	PMH-10M-AC120V	PMH-30M-AC120V	PMH-10H-AC120V	PMH-30H-AC120V
	200 to 240 V AC	PMH-10M-AC220V	PMH-30M-AC220V	PMH-10H-AC220V	PMH-30H-AC220V
	12 V DC	PMH-10M-DC12V	PMH-30M-DC12V	PMH-10H-DC12V	PMH-30H-DC12V
	24 V DC	PMH-10M-DC24V	PMH-30M-DC24V	PMH-10H-DC24V	PMH-30H-DC24V
	48 V DC	PMH-10M-DC48V	PMH-30M-DC48V	PMH-10H-DC48V	PMH-30H-DC48V
	100 to 110 V DC	PMH-10M-DC100V	PMH-30M-DC100V	PMH-10H-DC100V	PMH-30H-DC100V

- Notes: 1. 24 V AC type can also be ordered. Please inquire about pricing and any other details.  
 2. If embedding, please use the flush type mounting frame for that purpose.  
 3. Please order with a "9" at the end of the part number for UL and CSA certified products. Please inquire about pricing and any other details.

## Time range

Time range	Scale intervals
1.0	0.05
3.0	0.1
10	0.5
30	1

## Operation mode

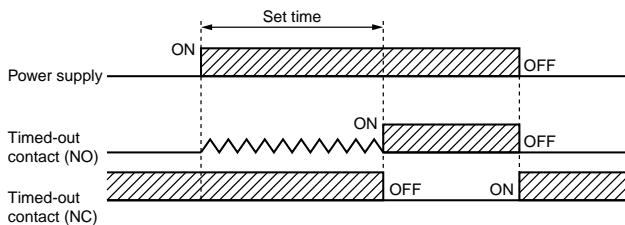

# Specifications

Type		PMH Timers	
		AC operating type	DC operating type
Rated operating voltage		100 to 120V, 200 to 240V (50/60Hz common)	12V, 24V, 48V, 100 to 110V
Rated power consumption		Max. 3VA	Max. 2W
Rated control capacity		7A 250V AC (resistive load)	
Operation mode		ON-delay	
Time accuracy	Operating time fluctuation & Power off time change error	[Except 1s range] Within $\pm 0.5\%$ * [1s range]: Within $\pm(0.5\%+10\text{ms})$ (power off time change at the range of 0.1 s to 1 h)	
	Voltage error	[Except 1s range] Within $\pm 0.5\%$ * [1s range]: Within $\pm(0.5\%+10\text{ms})$ (at the operating voltage changes between $-20$ to $+10\%$ )	
	Temperature error	Within $\pm 5\%$ (at $20^\circ\text{C}$ $68^\circ\text{F}$ ambient temp. at the range of $-10$ to $+50^\circ\text{C}$ $+14$ to $+122^\circ\text{F}$ )	
	Setting error	Within $\pm 10\%$ (Full-scale value)	
Output arrangement		Timed-out 2 Form C	
Contact resistance (Initial value)		Max. $50\text{m}\Omega$ (By voltage drop 6V DC 1A)	
Expected life (min. operations)	Mechanical (constant)	Min. $5 \times 10^7$	
	Electrical (constant)	Min. $2 \times 10^5$ (at rated control capacity)	
Allowable operating voltage range		80 to 110% of rated operating voltage	
Insulation resistance (Initial value)		Min. $100\text{M}\Omega$ (at 500V DC) Between input and output Between contact sets Between contacts	
Breakdown voltage (Initial value)		2000Vrms for 1min Between input and output 2000Vrms for 1min Between contact sets 1000Vrms for 1min Between contacts	
Power off time		Max. 0.1s	
Vibration resistance	Functional	10 to 55Hz: 1 cycle/min double amplitude of 0.5mm (10min on 3 axes)	
	Destructive	10 to 55Hz: 1 cycle/min double amplitude of 0.75mm (1h on 3 axes)	
Shock resistance	Functional	Min. $98\text{m/s}^2$ (4 times on 3 axes)	
	Destructive	Min. $980\text{m/s}^2$ (5 times on 3 axes)	
Ambient temperature		$-10$ to $50^\circ\text{C}$ $+14$ to $122^\circ\text{F}$	
Ambient humidity		30 to 85% RH (at $20^\circ\text{C}$ $68^\circ\text{F}$ , non-condensing)	
Ripple factor		—	Full-wave rectified (Approx. 48%)

## Dimensions (mm inch)

The CAD data of the products with a **CAD Data** mark can be downloaded from: <http://panasonic-electric-works.net/ac>

General tolerance:  $\pm 1.0 \pm 0.039$

### CAD Data

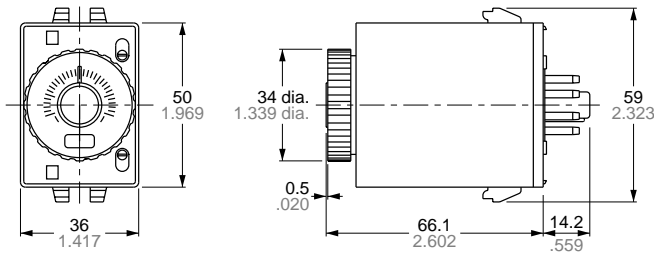

## Terminal layouts and Wiring diagrams

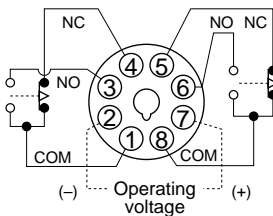

▲▲▲ : Timed cut contact

○ ○ : Instantaneous contact



Note: For the DC type, No. 2 terminal is (-).

\*For installation parts, please refer to "PMH TIMER OPTIONS" on page 168.

# PMH TIMER OPTIONS

## Flush Type

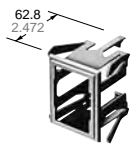
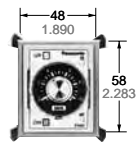
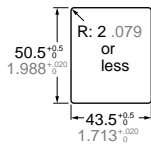
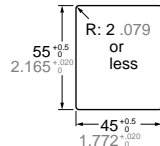
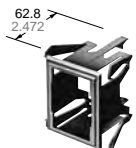
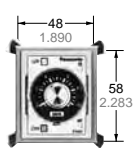
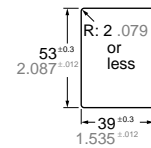
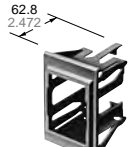
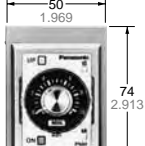
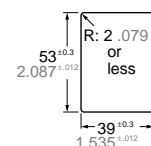
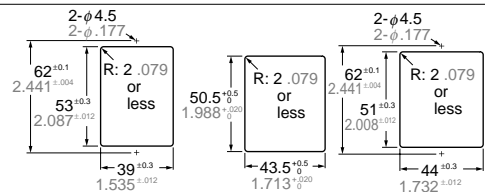
### ■ Flush type mounting frame

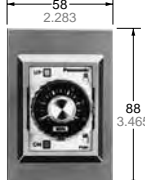
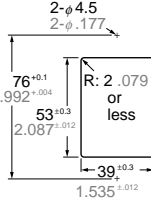
Appearance	Color	Model number	Front View (Installing onto control panel)	Mounting Hole Dimensions (Unit: mm inch)	
				Recommended Hole (For newly designed frame)	Applicable Mounting Hole (For installing in the old hole)
	Gray	AT7851 N-TF-H-GR		 *Distance between parallel drilled holes: 6.5 mm or more	 *Distance between parallel drilled holes: 5 mm or more
	Black	AT7852 N-TF-H-B			
	Silver Gray	AT7853 N-TF-H-SG			
	Gray	AT7811 N-TF-K-GR		 *Distance between parallel drilled holes: 11 mm or more	
	Black	AT7812 N-TF-K-B			
	Silver Gray	AT7813 N-TF-K-SG			
	Gray	AT7821 N-TF-YC-GR		 *Distance between parallel drilled holes: 13 mm or more	 *Distance between parallel drilled holes: 13 mm or more    *Distance between parallel drilled holes: 8.5 mm or more    *Distance between parallel drilled holes: 8 mm or more
	Black	AT7822 N-TF-YC-B			
	Silver Gray	AT7823 N-TF-YC-SG			
	Gray	AT7831 N-TF-Y-GR		 *Distance between parallel drilled holes: 21 mm or more	

#### Notes:

- The thickness of all applicable panels ranges from 1.0 to 3.5 mm .039 to .138 inch.
- \* indicates the distance between the mounting holes which are parallel cut on the panel.

## Installation

1. Insert the mounting frame surface into the panel from its front surface.

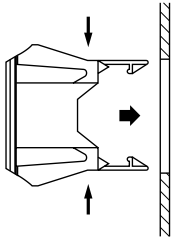

Note: The panel which is installed onto the flush type mounting frame for the timer cannot be inserted. (However, the installation order is not specified when the flush type mounting frame (type S) is used.)

2. After installing the panel, insert the timer to be used from the back of the panel.

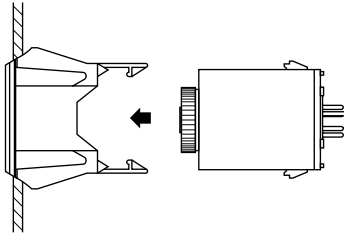

When an applicable timer comes in contact with the collar of the mounting frame, stop the timer by pressing the upper and lower hooks in the direction indicated by arrow. Use rear terminal socket (AT78041) or 8P cap (AD8-RC) for the connection wiring.

3. Hang the hooks on the timer base to secure the timer to the flush type mounting frame.

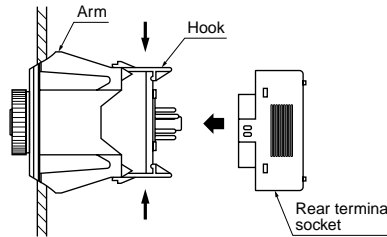
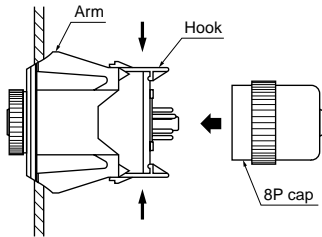

## Removal

Remove the timer in the reverse order of installation.

### • Compact timer protective cover

Model number: N-TC



#### ■ Features

1. The cover prevents the timer from operating improperly after setting the time. It also works as a compact dust cover.
2. The cover is applicable for all types of the fingertip flush type mounting frames for the compact timer.

### ■ Installation

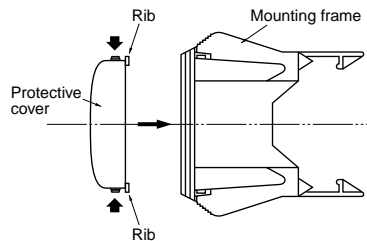

Press the points on the protective cover (indicated by arrows) to bend the ribs, and hook the ribs inside the mounting frame window. The protective cover can be installed if the timer is inserted into the mounting frame.

### ■ Dimensions (Unit: mm inch)

Tolerance:  $\pm 0.3 \pm .012$

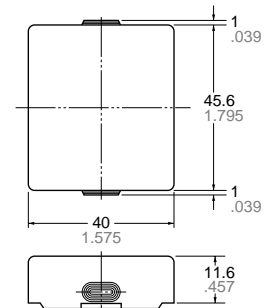

• **8P cap** When a flush type mounting frame is used for the exposed type, 8P cap should be installed.

Model number: AD8-RC

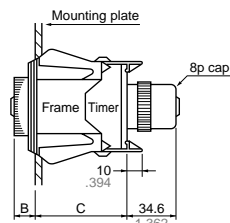

The dimensions B and C are shown in the table below.

(Unit: mm, inch)

Mounting frame to be used	Dimension B	Dimension C
Type H Type K	13.1	52.8
Type MHP Type MHP-M Type S	14.6	51.3

• **Rear terminal socket: M3.5** Applicable for 8-pin type

Tolerance:  $\pm 1 \pm .039$

Model number: AT78041

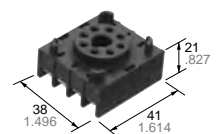



# PMH TIMER OPTIONS

## ■ Accessory

### Used for the exposed type

(Unit: mm inch), General tolerance:  $\pm 1 \pm .039$

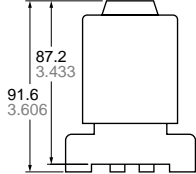
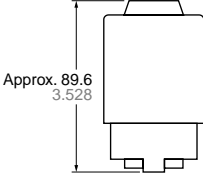
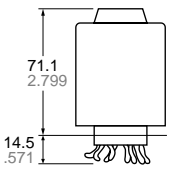
	<ul style="list-style-type: none"> <li>• DIN terminal socket</li> </ul> 	<ul style="list-style-type: none"> <li>• Timer rear terminal socket</li> </ul> 	<ul style="list-style-type: none"> <li>• GT pipe socket</li> </ul> 
<p>Model number</p>	<p>AT8-RFD</p>	<p>AT78041</p>	<p>AW68102</p>

For details, please refer to "PMH TIMER OPTIONS" on page 170.

### Used for the flush type

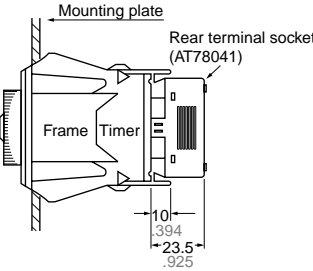
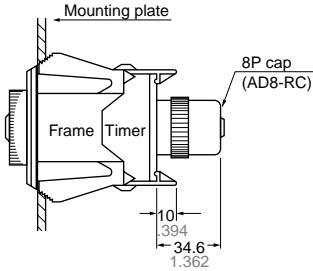
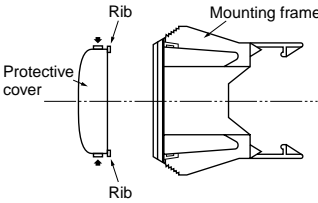
 <p>Flush type mounting frame</p>	<ul style="list-style-type: none"> <li>• Compact timer rear terminal socket</li> </ul> 	<ul style="list-style-type: none"> <li>• 8P cap</li> </ul> 	<ul style="list-style-type: none"> <li>• Compact timer protective cover</li> </ul> 
<p>Model number</p>	<p>AT78041</p>	<p>AD8-RC</p>	<p>N-TC</p>

For details, please refer to "PMH TIMER OPTIONS" on page 168.

# PRECAUTIONS IN USING PMH TIMERS

---

## Precautions during usage

- In order to maintain the characteristics of PHM timer, do not remove the case.
- Please use within an ambient temperature range of  $-10$  to  $+50^{\circ}\text{C}$   $+14$  to  $122^{\circ}\text{F}$  and in humidity no greater than 85% RH.
- Prevent using PMH timer in such places where flammable or corrosive gas is generated, a lot of dust exists or considerable shock and vibration occur.
- Since the main body cover is made of polycarbonate resin, prevent contact with organic solvents such as methyl alcohol, benzene and thinner, or string alkali materials such as ammonia and caustic soda.
- Do not make direct solder connections to the round pins.
- Carefully verify the terminal numbers when wiring the terminal socket and cap.
- When rotating the knob, note that there are stoppers located just past the “0” side and the full scale side. Therefore, do not use unreasonable force.
- Please use with a time setting that is no less than the minimum time limit. The minimum time limit is indicated on the dial by the  $\downarrow$  mark.
- The contacts will not operate if the needle is adjusted to the “0” position when the power is off.
- **Phase synchronization for AC load switching**  
When timer output contact will be synchronized to the AC power phase, the electrical life may be compromised and locking (contact reset failure) may occur due to contact welding or contact transference. Therefore, please conduct tests using actual equipment.