



The Future of Analog IC Technology®

# MP2603

## Single-Cell 150mA Linear Li-Ion Battery Charger

### DESCRIPTION

The MP2603 is a low cost single cell Li-ion battery charger IC suitable for low charge current applications. It features constant current (CC) and constant voltage (CV) charging modes with programmable charge current (50mA–150mA), trickle charge and charge status indication.

The MP2603 is enabled with an input supply voltage greater than 3.5V. The charger IC is disabled when unplugged from the AC adaptor. To minimize the charger’s total solution cost, the MP2603 does not need an external reverse blocking diode, a precision current-sense resistor or a compensation capacitor at the output. MP2603 is available in a 5-pin TSOT23 package.

### EVALUATION BOARD REFERENCE

Board Number	Dimensions
EV2603EJ-00B	1.4”X x 1.1”Y x 0.5”Z

### FEATURES

- $V_{IN}$  Surge Up to 25V
- 0.75%  $V_{BATT}$  Accuracy
- Low Battery Reverse Current, ( $< 1\mu A$ )
- Programmable Charge Current
- Over Temperature Protection
- Over Current Protection
- Charge Status Indication
- Over Charge Protection
- No External Sense Resistor Required
- No External Reverse Blocking Diode Required
- No Output Capacitor Required for Stability

### APPLICATIONS

- Bluetooth Headset
- MP3 Players
- Mini PDAs
- Cell Phones
- Digital Cameras

All MPS parts are lead-free and adhere to the RoHS directive. For MPS green status, please visit MPS website under Products, Quality Assurance page. "MPS" and "The Future of Analog IC Technology" are registered trademarks of Monolithic Power Systems, Inc.

### TYPICAL APPLICATION

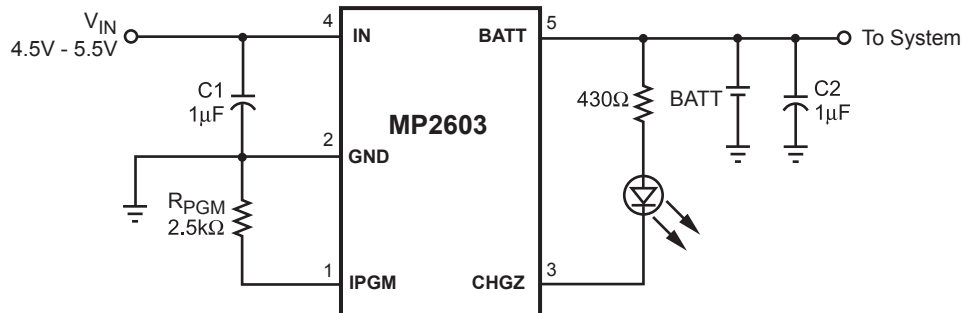

### ORDERING INFORMATION

Part Number*	Package	Top Marking
MP2603EJ	TSOT23	M3

\* For Tape & Reel, add suffix -Z (e.g. MP2603EJ-Z).  
 For RoHS compliant packaging, add suffix -LF (e.g. MP2603EJ-LF-Z)

### PACKAGE REFERENCE

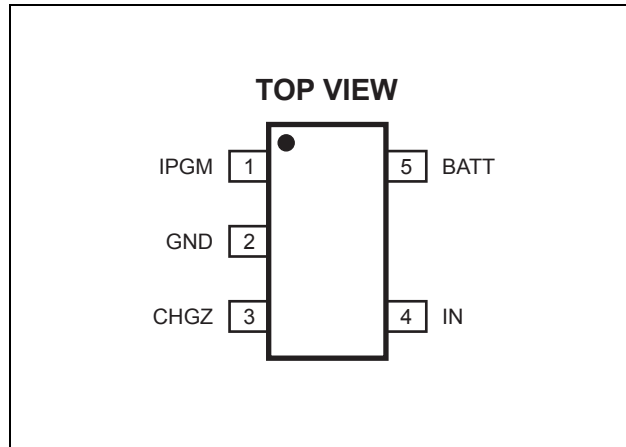

#### ABSOLUTE MAXIMUM RATINGS <sup>(1)</sup>

IN to GND .....-0.3V to +25V  
 All Other Pins .....-0.3V to +6.5 V  
 Continuous Power Dissipation ( $T_A = +25^\circ\text{C}$ ) <sup>(2)</sup>  
 ..... 0.57W  
 Junction Temperature ..... 140°C  
 Lead Temperature ..... 260°C  
 Storage Temperature..... -65°C to +150°C

#### Recommended Operating Conditions <sup>(3)</sup>

Supply Voltage  $V_{IN}$  ..... 4.75V to 5.25V  
 Operating Temperature..... -20°C to +85°C

#### Thermal Resistance <sup>(4)</sup>

	$\theta_{JA}$	$\theta_{JC}$
TSOT23 .....	220	110 .. °C/W

#### Notes:

- Exceeding these ratings may damage the device.
- The maximum allowable power dissipation is a function of the maximum junction temperature  $T_J$  (MAX), the junction-to-ambient thermal resistance  $\theta_{JA}$ , and the ambient temperature  $T_A$ . The maximum allowable continuous power dissipation at any ambient temperature is calculated by  $P_D$  (MAX) =  $(T_J$  (MAX) -  $T_A$ ) /  $\theta_{JA}$ . Exceeding the maximum allowable power dissipation will cause excessive die temperature, and the regulator will go into thermal shutdown. Internal thermal shutdown circuitry protects the device from permanent damage.
- The device is not guaranteed to function outside of its operating conditions.
- Measured on JESD51-7, 4-layer PCB.

## ELECTRICAL CHARACTERISTICS

$V_{IN} = 5V$ ,  $T_A = +25^{\circ}C$ , unless otherwise noted.

Parameter	Symbol	Condition	Min	Typ	Max	Units
Supply Current from $V_{IN}$	$I_{SUPPLY}$	$I_{CHG} = 0A$		0.5		mA
Input Under Voltage Lockout		Input Falling	1.8	2.3	2.8	V
Battery Reverse Current to BATT Pin		$V_{BATT} = 4V$ , Input = GND or Float			2	$\mu A$
Battery Voltage Regulation	$V_{BATT}$	$I_{CHG} = 5mA$ , $0^{\circ}C < T_A < +50^{\circ}C$	4.16	4.20	4.24	V
Constant Current Regulation <sup>(5)</sup>	$I_{CHG}$	$V_{IN} = 5V$ , $V_{BATT} = 3.8V$ , $R_{PGM} = 2.5k\Omega$	135	150	165	mA
		$V_{IN} = 5V$ , $V_{BATT} = 3.8V$ , $R_{PGM} = 1.5k\Omega - 7.2k\Omega$ , $-20^{\circ}C < T_A < +85^{\circ}C$	90	100	110	% $I_{CHG}$
		$V_{IN} = 5V$ , $V_{BATT} = 3.8V$ , $7.2k\Omega < R_{PGM} \leq 12.4k\Omega$ , $-20^{\circ}C < T_A < +85^{\circ}C$	70		130	% $I_{CHG}$
Trickle Charge Current		$V_{IN} = 5V$ , $V_{BATT} = 2.3V$	5	10	15	% $I_{CHG}$
Trickle Threshold Voltage			2.45	2.60	2.75	V
Trickle Voltage Hysteresis				190		mV
CHGZ Low-to-High Threshold			3	10	17	% $I_{CHG}$
CHGZ Sink Current		Pin Voltage = 0.2V	5			mA
Dropout Voltage		$I_{CHG} = 150mA$ , $V_{BATT} = 3.8V$		640		mV
Thermal Limit <sup>(6)</sup>				130		$^{\circ}C$
Overcharge Protection		$V_{BATT} = 4.25V$			0	$\mu A$

**Notes:**

5)  $I_{CHG}$  is the target preprogrammed charge current (Die temperature below 110 $^{\circ}C$ ).

6) Guaranteed by design.

## PIN FUNCTIONS

Pin #	Name	Description
1	IPGM	Charge Current Program Pin. Connect to a resistor to program the charge current. Do not connect a capacitor to this pin.
2	GND	Chip Ground Return. Connect to the system ground.
3	CHGZ	Open-Drain Charge Status Indication Pin. It can be connected through an LED and a 430Ω resistor to BATT for visual indication or through a 1kΩ resistor to BATT for use with a microcontroller.
4	IN	Input Supply Pin. Connect to a 5V (±5%) power supply. The maximum surge voltage must be less than 25V. Decouple this pin with a minimum of 0.1μF ceramic capacitor.
5	BATT	Charger Output. Connect to the battery. Placing a capacitor to GND on this pin is optional.

## BLOCK DIAGRAM

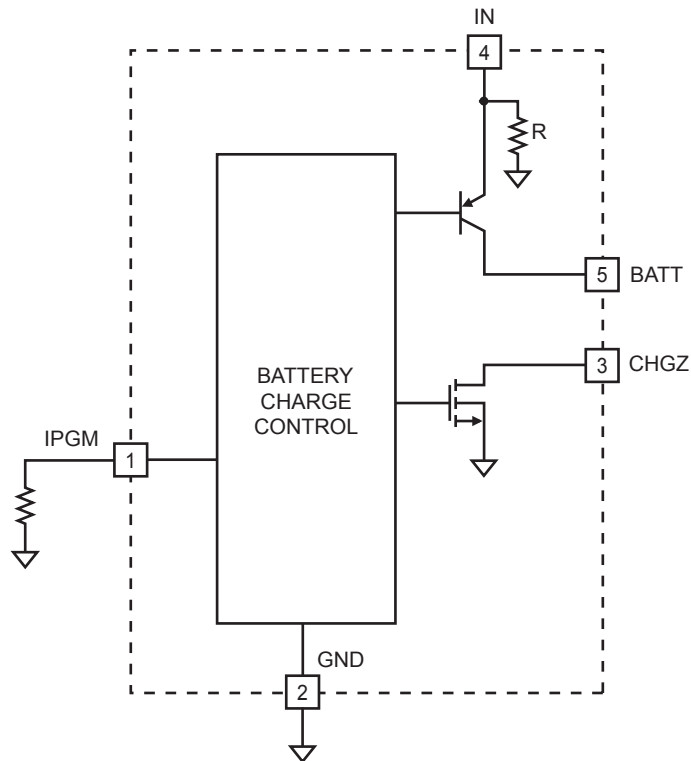
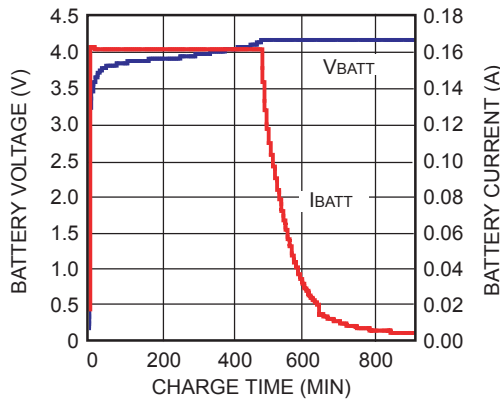

**Figure 1—Functional Block Diagram**

## TYPICAL PERFORMANCE CHARACTERISTICS

$V_{IN} = 5V$ ,  $C1 = 1\mu F$ ,  $C2 = 1\mu F$ ,  $T_A = +25^\circ C$ , unless otherwise noted.

**Battery Charge Curve**



**Charge Current vs Battery Voltage**

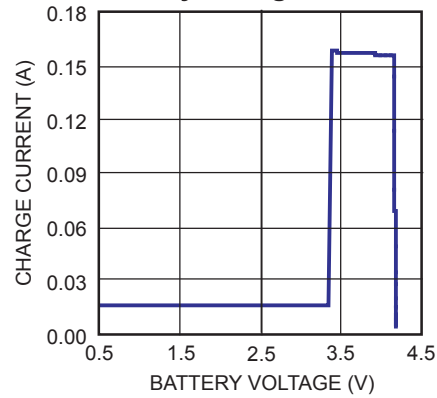

**Battery Voltage vs Input Voltage**

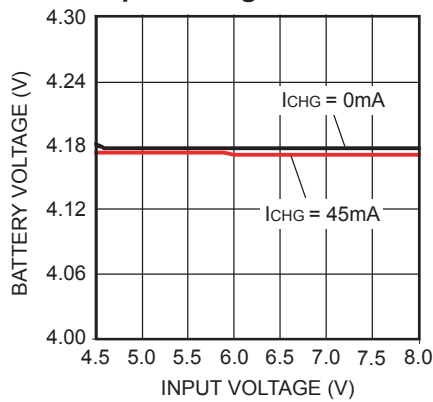

**Charge Current vs Battery Voltage**

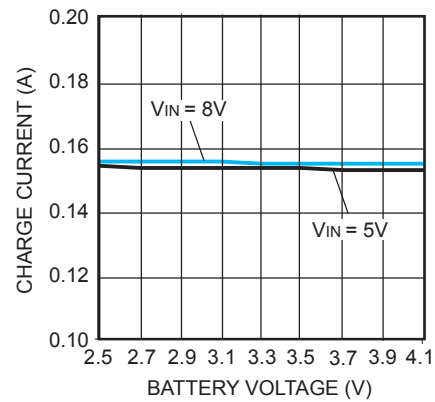

**Charge Current vs Input Voltage**

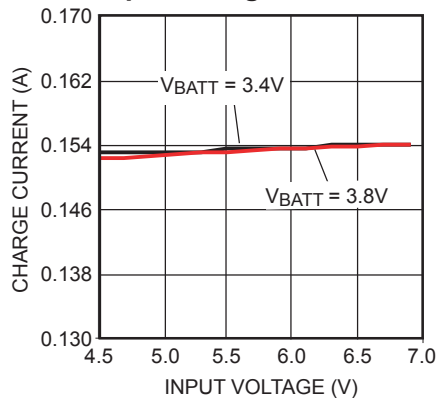

**Charge Current vs R<sub>PGM</sub> Resistance**

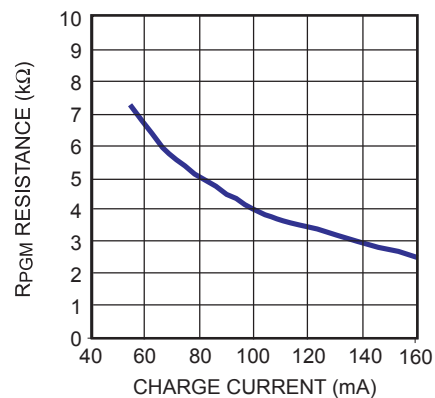

**TYPICAL PERFORMANCE CHARACTERISTICS (continued)**

$V_{IN} = 5V$ ,  $C1 = 1\mu F$ ,  $C2 = 1\mu F$ ,  $T_A = +25^\circ C$ , unless otherwise noted.

**Forward Leakage Current**

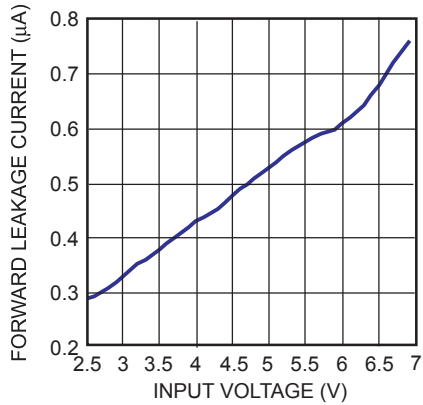

**Reverse Current vs Battery Voltage**

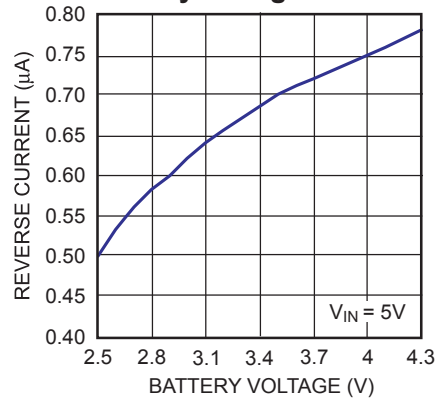

**Charge Current vs Temperature**

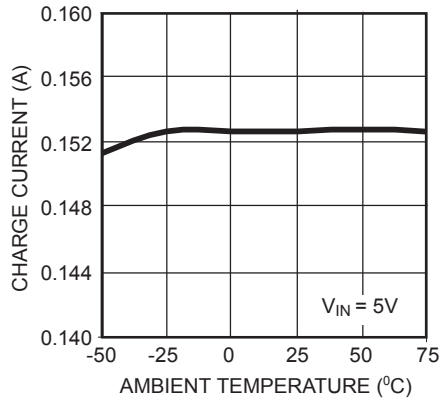

**Battery Voltage vs Temperature**

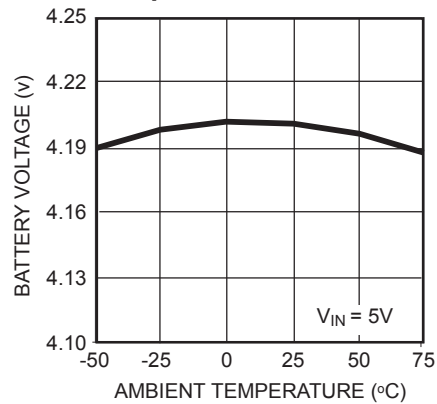

**Power-On**

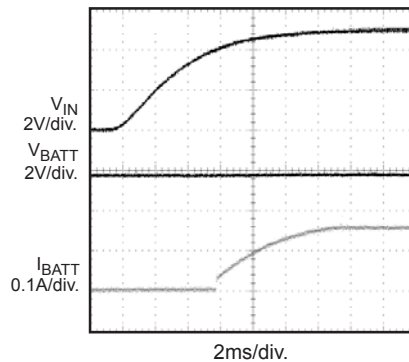

**Power-Off**

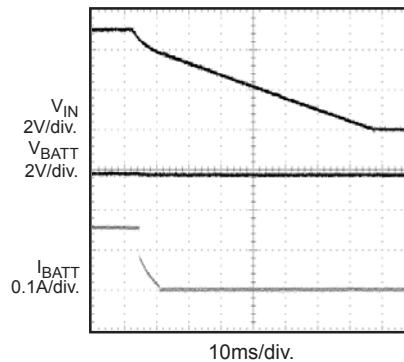

**OPERATION**

The MP2603 is enabled with a minimum input supply voltage of 3.5V. This power supply must also be higher than both the UVLO threshold and the battery voltage. There is an internal 500kΩ pull-down resistor connecting the IN and GND pins. The MP2603 provides CC/CV charge algorithms to automatically change modes depending on the battery status. Figure 2 shows the typical charging procedure for the MP2603.

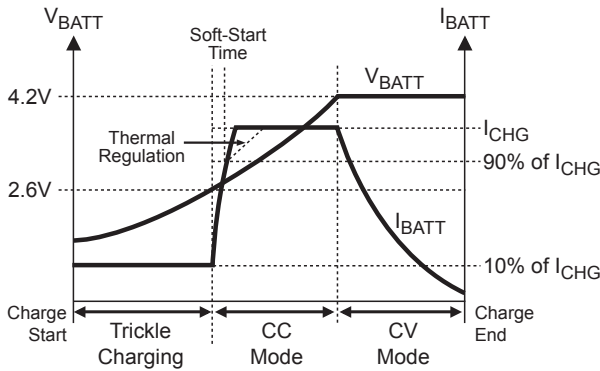

**Figure 2—MP2603 Typical Charging Procedure**

The charge current,  $I_{CHG}$ , is programmed by connecting a resistor ( $R_{PGM}$ ) from the  $I_{PGM}$  pin to ground. The relationship of the charge current and the programming resistance is established by the following equation and graph. The Table 1 lists the typical application setting of  $I_{chg}$ .

$$I_{CHG} = 150mA \times \frac{2.53k\Omega}{R_{PGM}} \quad (1)$$

**Table 1—  $R_{PGM}$  and  $I_{CHG}$  Relationship**

$R_{PGM}$ (kΩ)	$I_{CHG}$ (mA)
12.4	30
7.2	52
4.99	76
3.74	101
2.5	151

**Charge Current vs 1/ $R_{PGM}$  Resistance**

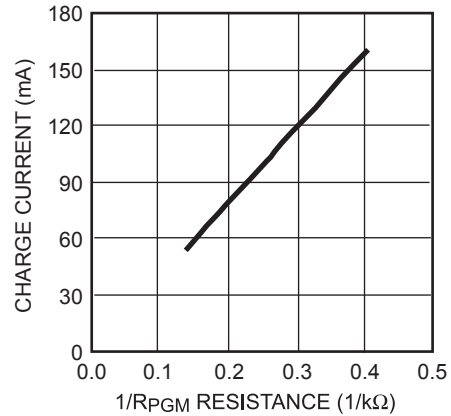

**Figure 3— Charge Current vs 1/ $R_{PGM}$  Resistance**

When battery voltage falls below the trickle threshold (2.6V), charge current is limited to 10% of the programmed value to trickle charge the fully depleted battery. After the battery voltage reaches 2.6V, the charger begins to charge at the constant current of the programmed value ( $I_{CHG}$ ). This is referred to as Constant Current (CC) mode. Once the battery voltage reaches 4.2V, the charger will operate in the Constant Voltage (CV) mode until the battery is fully charged.

**Charge Status (CHGZ)**

The open-drain CHGZ pin monitors charge status by connecting to  $V_{BATT}$  through an LED and/or a resistor. The end-of-charge, or battery full, is indicated by the CHGZ pin changing from LOW to HIGH (i.e. LED turns off) when  $I_{CHG}$  decreases to 10% of the programmed value.

**Thermal Protection**

To prevent overheating, the MP2603 automatically limits the die temperature to 130°C by reducing the internal current-setting reference voltage. In the thermal protection mode, the charge current reduces automatically, but remains continuous.

**APPLICATION**

**Flow Chart of Operation**

Power-On Reset (POR) feature can be applied to the MP2603 to ensure that the device starts operating in a known state when power is applied. The flow chart in Figure 4 describes

the conditions and operation modes of the MP2603. CVC and CCC stand for “constant voltage charge” and “constant current charge”, respectively.

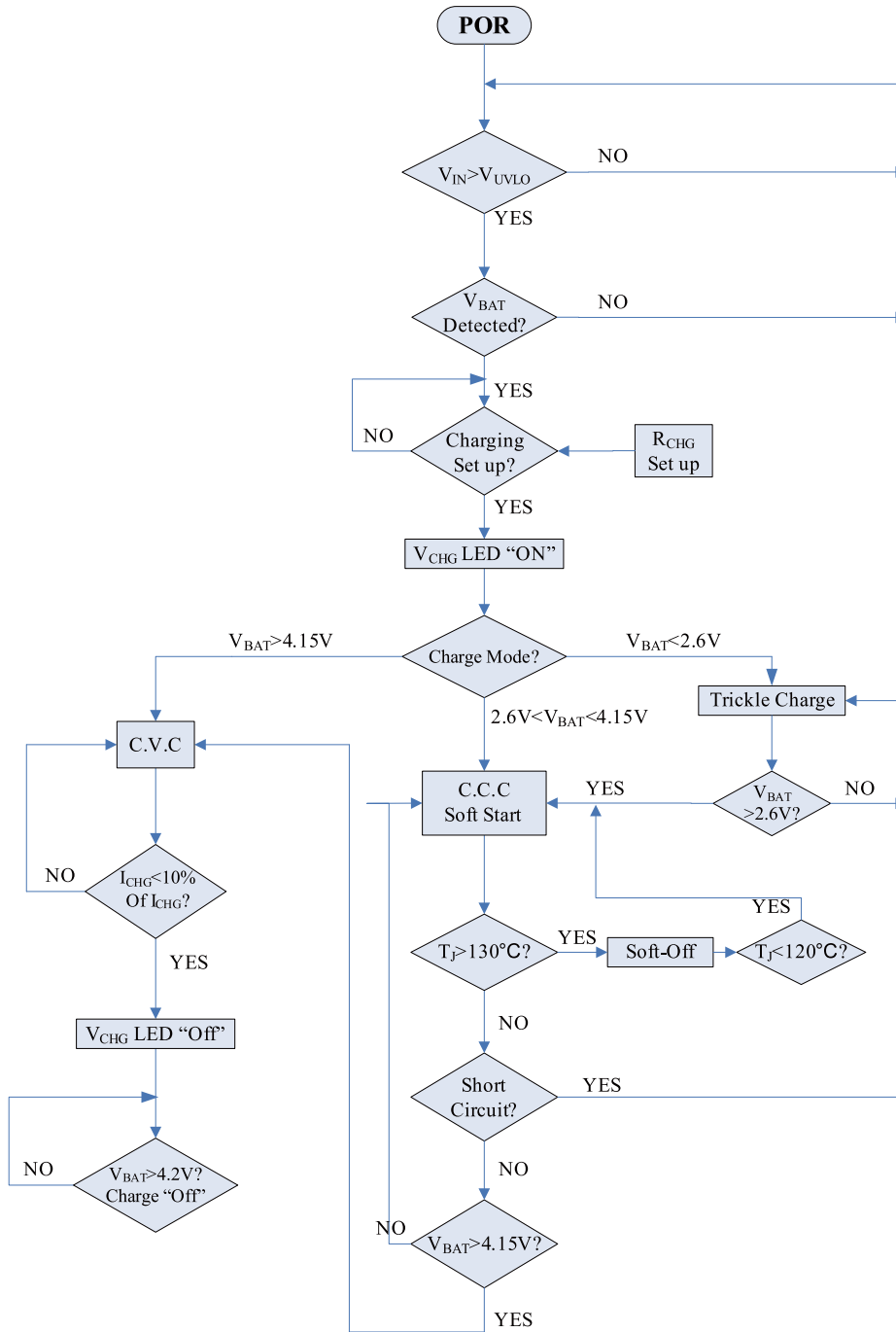

**Figure 4—Flow Chart of Operation**

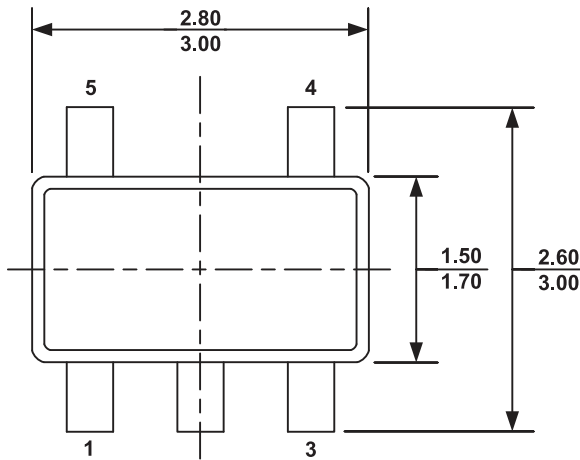
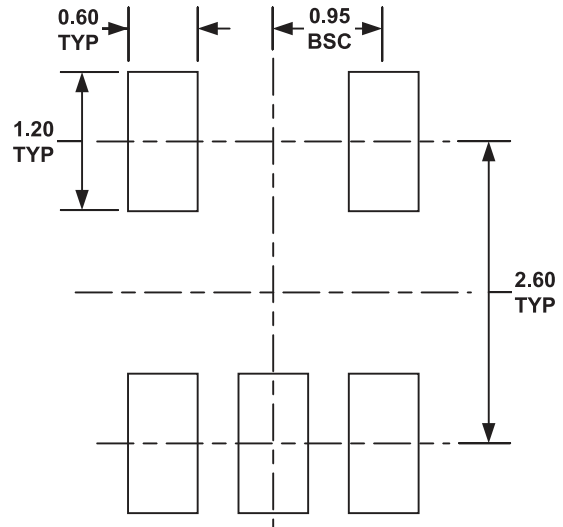
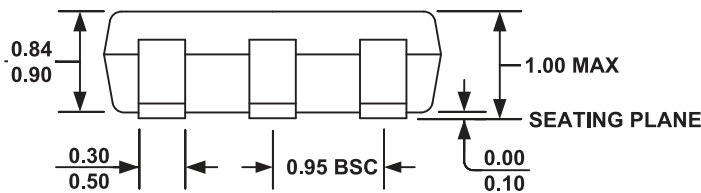
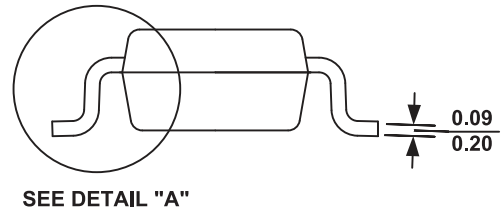
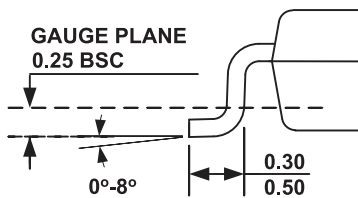

**PACKAGE INFORMATION**
**TSOT23-5**

**TOP VIEW**

**RECOMMENDED LAND PATTERN**

**FRONT VIEW**

**SIDE VIEW**

**DETAIL "A"**
**NOTE:**

- 1) ALL DIMENSIONS ARE IN MILLIMETERS.
- 2) PACKAGE LENGTH DOES NOT INCLUDE MOLD FLASH, PROTRUSION OR GATE BURR.
- 3) PACKAGE WIDTH DOES NOT INCLUDE INTERLEAD FLASH OR PROTRUSION.
- 4) LEAD COPLANARITY (BOTTOM OF LEADS AFTER FORMING) SHALL BE 0.10 MILLIMETERS MAX.
- 5) DRAWING CONFORMS TO JEDEC MO-193, VARIATION AA.
- 6) DRAWING IS NOT TO SCALE.

**NOTICE:** The information in this document is subject to change without notice. Users should warrant and guarantee that third party Intellectual Property rights are not infringed upon when integrating MPS products into any application. MPS will not assume any legal responsibility for any said applications.