

### Small Signal Diode

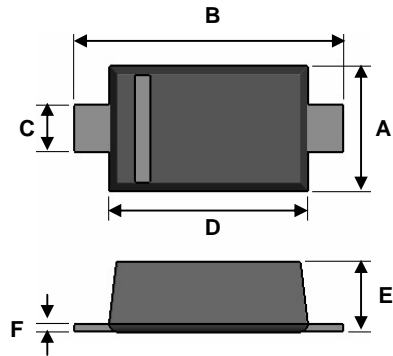

SOD-323F



### Features

- ✧ Flat Lead SOD-323F small outline plastic package
- ✧ Surface device type mounting
- ✧ Moisture sensitivity level 1
- ✧ Matte Tin(Sn) lead finish with Nickel(Ni) underplate
- ✧ Pb free version and RoHS compliant
- ✧ Green compound (Halogen free) with suffix "G" on packing code and prefix "G" on date code

### Mechanical Data

- ✧ Case : Flat lead SOD-323F small outline plastic package
- ✧ Terminal: Matte tin plated, solderable per MIL-STD-202, Method 208 guaranteed
- ✧ High temperature soldering guaranteed: 260°C/10s
- ✧ Polarity : Indicated by cathode band
- ✧ Weight : 4.5±0.5 mg
- ✧ Marking Code : S5, S6, S7

Dimensions (mm)	Unit (mm)		Unit (inch)	
	Min	Max	Min	Max
A	1.15	1.40	0.045	0.055
B	2.30	2.80	0.091	0.110
C	0.25	0.40	0.010	0.016
D	1.60	1.80	0.063	0.071
E	0.80	1.10	0.031	0.043
F	0.05	0.15	0.002	0.006

### Ordering Information

Part No.	Package	Packing Code	Packing	Marking
BAV19WS	SOD-323F	RR	3K / 7" Reel	S5
BAV20WS	SOD-323F	RR	3K / 7" Reel	S6
BAV21WS	SOD-323F	RR	3K / 7" Reel	S7
BAV19WS	SOD-323F	RRG	3K / 7" Reel	S5
BAV20WS	SOD-323F	RRG	3K / 7" Reel	S6
BAV21WS	SOD-323F	RRG	3K / 7" Reel	S7

### Pin Configuration



### Suggested PAD Layout

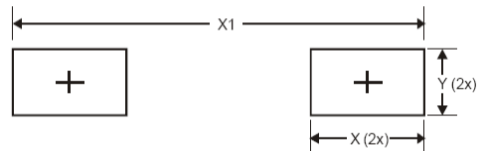

Dimensions	Value (in mm)
X	0.710
X1	2.900
Y	0.403

### Maximum Ratings and Electrical Characteristics

Rating at 25°C ambient temperature unless otherwise specified.

#### Maximum Ratings

Type Number	Symbol	Value	Units
Power Dissipation	$P_D$	200	mW
Repetitive Peak Reverse Voltage	$V_{RRM}$	250	V
Average Rectified Forward Current	$I_{F(AV)}$	200	mA
Non-Repetitive Peak Forward Surge Current	$I_{FSM}$	2.5	A
Pulse width= 1μs Pulse width= 1s		0.5	
Junction and Storage Temperature Range	$T_J, T_{STG}$	-65 to +150	°C

Note1. The suggested land pattern dimensions have been provided for reference only, as actual pad layouts may vary depending on application.

### Small Signal Diode

### Electrical Characteristics

Type Number	Symbol	Min	Max	Units	
Breakdown Voltage	$V_R$	BAV19W	120	-	V
		BAV20W (Note 2)	200	-	
		BAV21W	250	-	
Forward Voltage	$V_F$	$I_F=100\text{mA}$	-	1.00	V
		$I_F=200\text{mA}$	-	1.25	
Reverse Leakage Current	$I_R$	-	100	nA	
Junction Capacitance	$C_J$	-	5.0	pF	
Reverse Recovery Time	$T_{rr}$	-	50	ns	

### Tape & Reel specification

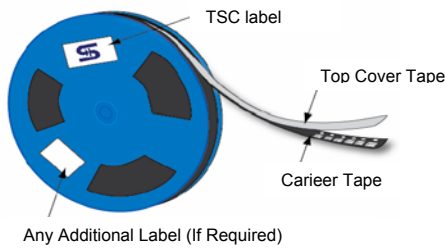

Item	Symbol	Dimension(mm)
Carrier depth	K	2.40 Max.
Sprocket hole	D	1.5 ± 0.1
Reel outside diameter	A	178 ± 1
Reel inner diameter	D1	50 Min.
Feed hole width	D2	13.0 ± 0.5
Sprocket hole position	E	1.75 ± 0.10
Punch hole position	F	3.50 ± 0.05
Sprocket hole pitch	P0	4.00 ± 0.10
Embossment center	P1	2.00 ± 0.10
Overall tape thickness	T	0.6 Max.
Tape width	W	8.30 Max.
Reel width	W1	14.4 Max

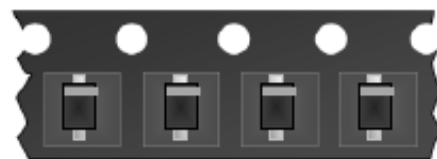
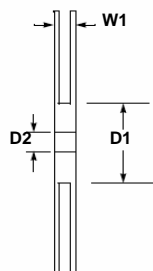
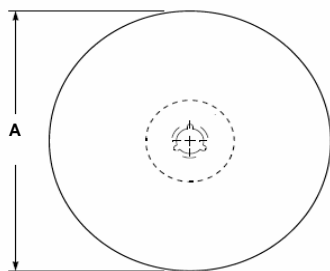
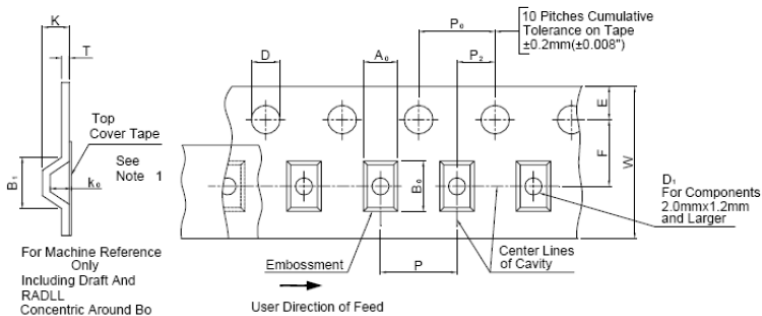

User Direction of Feed →

Note 2: Test Condition :  $I_R=100\mu\text{A}$

Note 3: Test Condition : BAV19WS @  $V_R=100\text{V}$ , BAV20WS @  $V_R=150\text{V}$ , BAV21WS @  $V_R=200\text{V}$

Note 4: Test Condition :  $I_F=I_R=30\text{mA}$ ,  $R_L=100\Omega$ ,  $I_{RR}=3\text{mA}$

Note 5: A0, B0, and K0 are determined by component size. The clearance between the components and the cavity must be within 0.05 mm min. to 0.5 mm max. The component cannot rotate more than 10° within the determined cavity.

Note 6: If B1 exceeds 4.2 mm(0.165") for 8 mm embossed tape, the tape may not feed through all tape feeders.

**Small Signal Diode**

**Rating and Characteristic Curves**

