



ENGLISH

Datasheet

RS Pro Centre Drills

BS Style: BS 328 / DIN 333A / ISO 866

RS Stock No: 408-7950

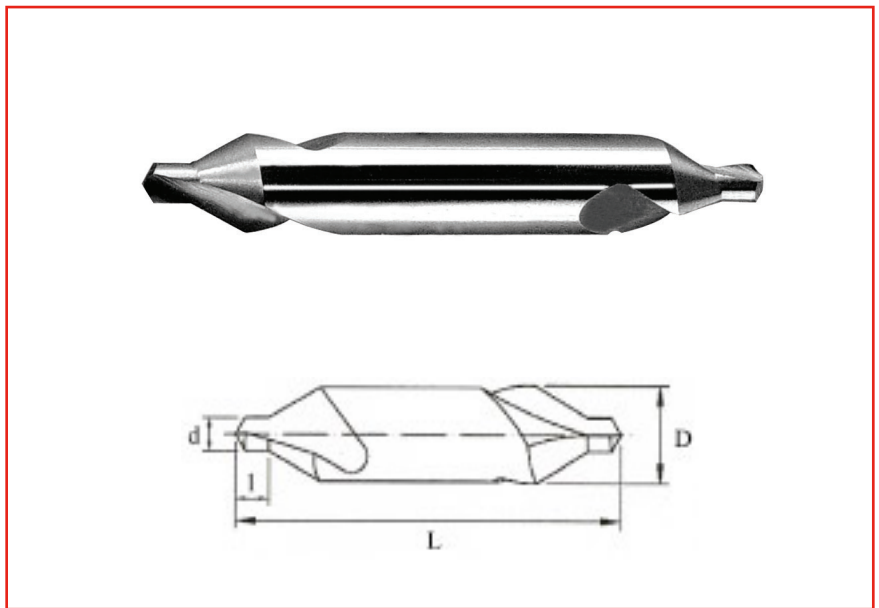

Specifications:

Produces conical centre holes in components which require machining between centres or a centre support to provide rigidity

Countersink angle: 60°

Point geometry: 120°

Right hand cutting

Silver finish

Supplied in plastic pack

RS Code	Manufacturers Code	Size	d (inch)	D (inch)	i (inch)	L (inch)
408-7950	22-100-005	BS5	3/16	7/16	1/4	2-1/2