

V_{DSS}	-20V
$R_{DS(on)}$ (Max.)	3.8Ω
I_D	-100mA
P_D	100mW

●Features

- 1) Ultra small Package (0806size).
- 2) Low voltage drive(-1.2V) makes this device ideal for portable equipment.
- 3) Drive circuits can be simple.
- 4) Built-in ESD Protection Diode.

●Application

Switching

●Outline

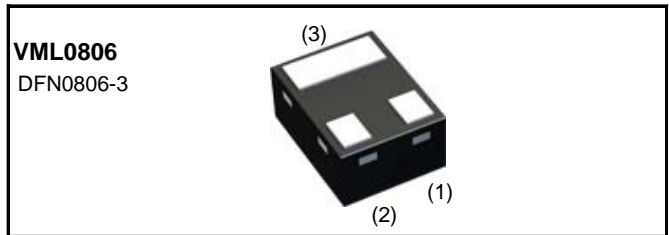

●Inner circuit

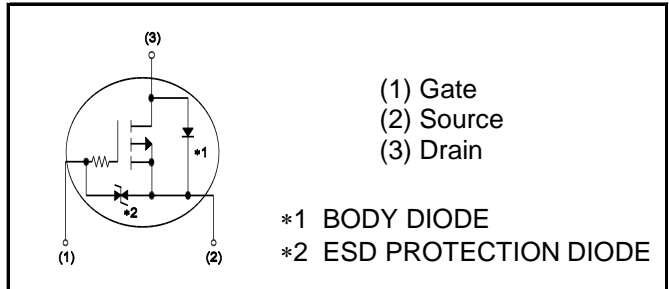

●Packaging specifications

Type	Packaging	Taping
	Reel size (mm)	180
	Tape width (mm)	8
	Basic ordering unit (pcs)	8,000
	Taping code	T2L
	Marking	RX

●Absolute maximum ratings($T_a = 25^\circ\text{C}$)

Parameter	Symbol	Value	Unit
Drain - Source voltage	V_{DSS}	-20	V
Continuous drain current	I_D^{*1}	±100	mA
Pulsed drain current	$I_{D,pulse}^{*2}$	±400	mA
Gate - Source voltage	V_{GSS}	±10	V
Power dissipation	P_D^{*3}	100	mW
Junction temperature	T_j	150	°C
Range of storage temperature	T_{stg}	-55 to +150	°C

●Thermal resistance

Parameter	Symbol	Values			Unit
		Min.	Typ.	Max.	
Thermal resistance, junction - ambient	R_{thJA}^{*3}	-	-	1250	°C/W

●Electrical characteristics($T_a = 25^\circ\text{C}$)

Parameter	Symbol	Conditions	Values			Unit
			Min.	Typ.	Max.	
Drain - Source breakdown voltage	$V_{(BR)DSS}$	$V_{GS} = 0V, I_D = -1mA$	-20	-	-	V
Zero gate voltage drain current	I_{DSS}	$V_{DS} = -20V, V_{GS} = 0V$	-	-	-1	μA
Gate - Source leakage current	I_{GSS}	$V_{GS} = \pm 10V, V_{DS} = 0V$	-	-	± 10	μA
Gate threshold voltage	$V_{GS(th)}$	$V_{DS} = -10V, I_D = -100\mu\text{A}$	-0.3	-	-1	V
Static drain - source on - state resistance	$R_{DS(on)}$ *4	$V_{GS} = -4.5V, I_D = -100mA$	-	2.5	3.8	Ω
		$V_{GS} = -2.5V, I_D = -50mA$	-	3.4	5.1	
		$V_{GS} = -1.8V, I_D = -20mA$	-	4.8	8.2	
		$V_{GS} = -1.5V, I_D = -10mA$	-	6.0	13.2	
		$V_{GS} = -1.2V, I_D = -1mA$	-	10.0	40.0	
		$V_{GS} = -4.5V, I_D = -100mA, T_j = 125^\circ\text{C}$	-	3.3	6.6	
Transconductance	g_{fs} *4	$V_{DS} = -10V, I_D = -100mA$	120	-	-	mS

*1 Limited only by maximum temperature allowed.

*2 $P_w \leq 10\mu\text{s}$, Duty cycle $\leq 1\%$

*3 Each terminal mounted on a recommended land

*4 Pulsed

●Electrical characteristics($T_a = 25^\circ\text{C}$)

Parameter	Symbol	Conditions	Values			Unit
			Min.	Typ.	Max.	
Input capacitance	C_{iss}	$V_{GS} = 0V$	-	15.0	-	pF
Output capacitance	C_{oss}	$V_{DS} = -10V$	-	4.0	-	
Reverse transfer capacitance	C_{rss}	$f = 1\text{MHz}$	-	1.5	-	
Turn - on delay time	$t_{d(on)}^{*4}$	$V_{DD} \approx -10V, V_{GS} = -4.5V$	-	46	-	ns
Rise time	t_r^{*4}	$I_D = -50\text{mA}$	-	62	-	
Turn - off delay time	$t_{d(off)}^{*4}$	$R_L = 200\Omega$	-	325	-	
Fall time	t_f^{*4}	$R_G = 10\Omega$	-	137	-	

●Body diode electrical characteristics (Source-Drain)($T_a = 25^\circ\text{C}$)

Parameter	Symbol	Conditions	Values			Unit
			Min.	Typ.	Max.	
Continuous source current	I_S^{*1}	$T_a = 25^\circ\text{C}$	-	-	-80	mA
Pulsed source current	I_{SM}^{*2}		-	-	-400	mA
Forward voltage	V_{SD}^{*4}	$V_{GS} = 0V, I_S = -100\text{mA}$	-	-	-1.2	V

●Electrical characteristic curves

Fig.1 Power Dissipation Derating Curve

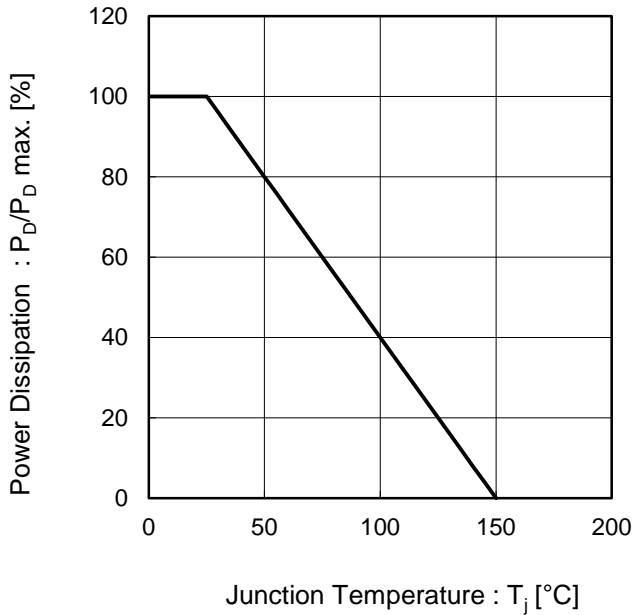

Fig.2 Drain Current Derating Curve

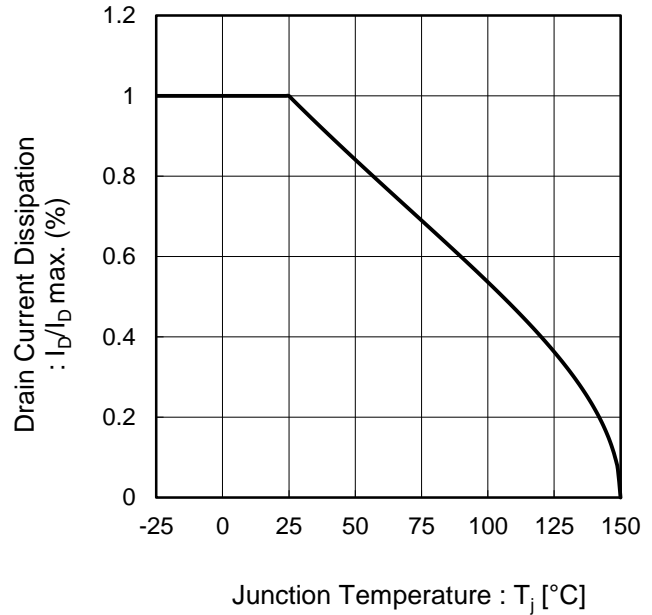

Fig.3 Typical Output Characteristics(I)

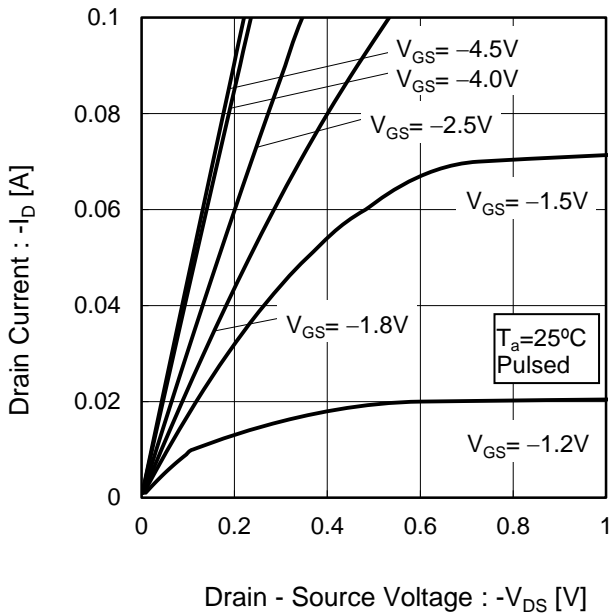
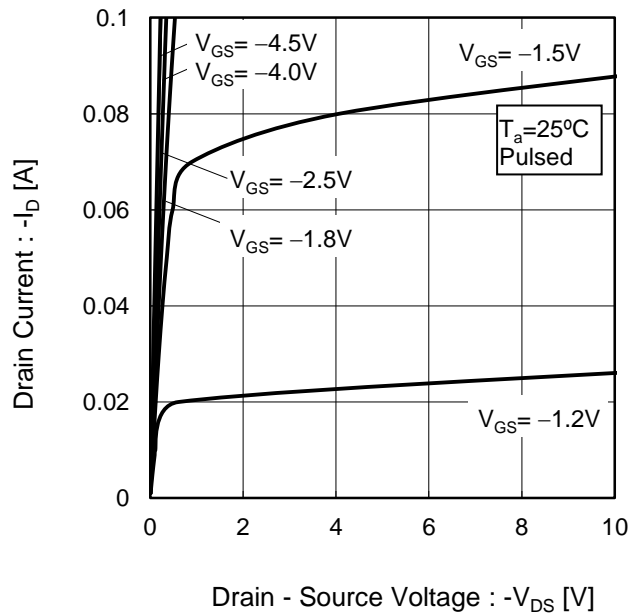

Fig.4 Typical Output Characteristics(II)



●Electrical characteristic curves

Fig.5 Breakdown Voltage vs. Junction Temperature

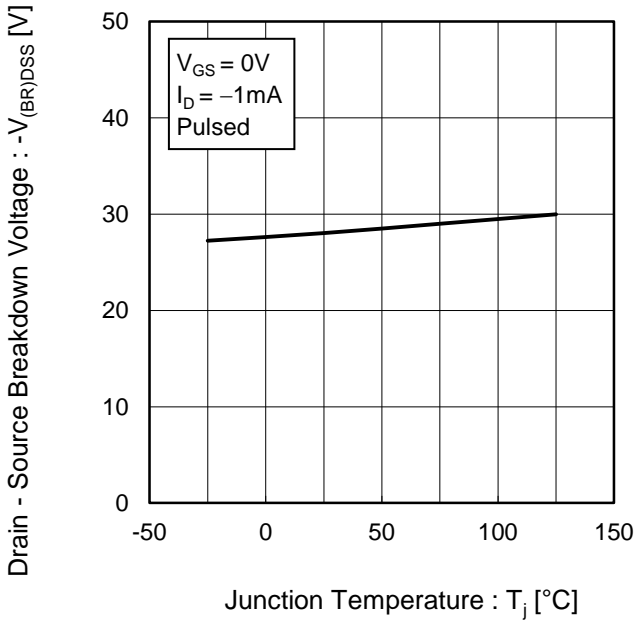

Fig.6 Typical Transfer Characteristics

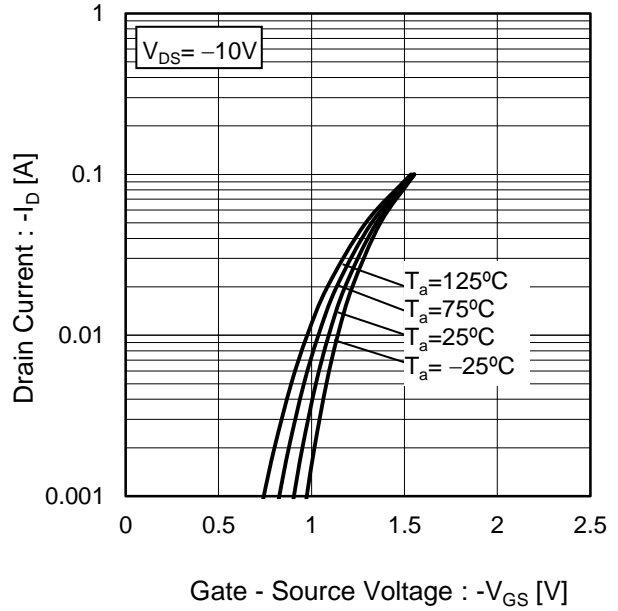

Fig.7 Gate Threshold Voltage vs. Junction Temperature

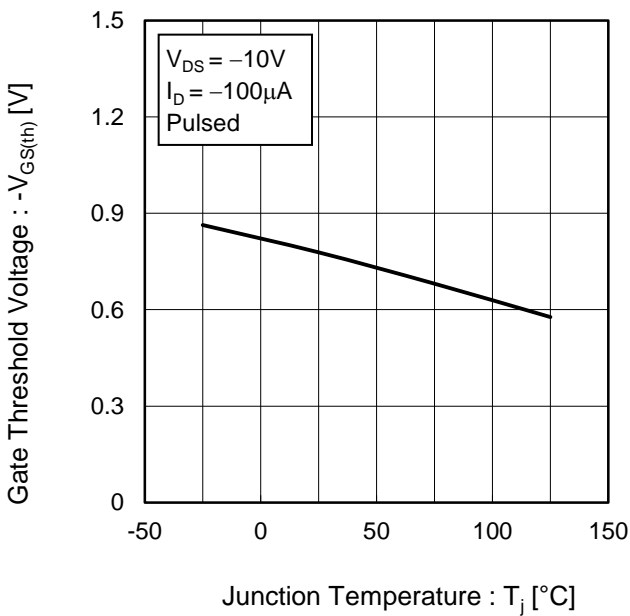
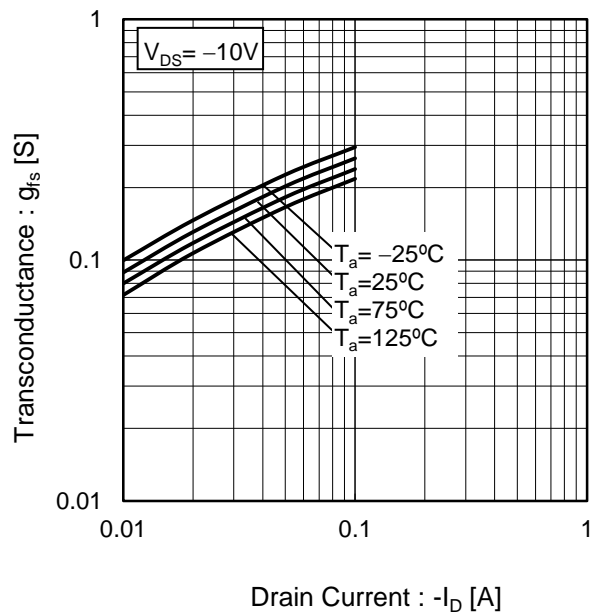

Fig.8 Transconductance vs. Drain Current



●Electrical characteristic curves

Fig.9 Static Drain - Source On - State Resistance vs. Gate Source Voltage

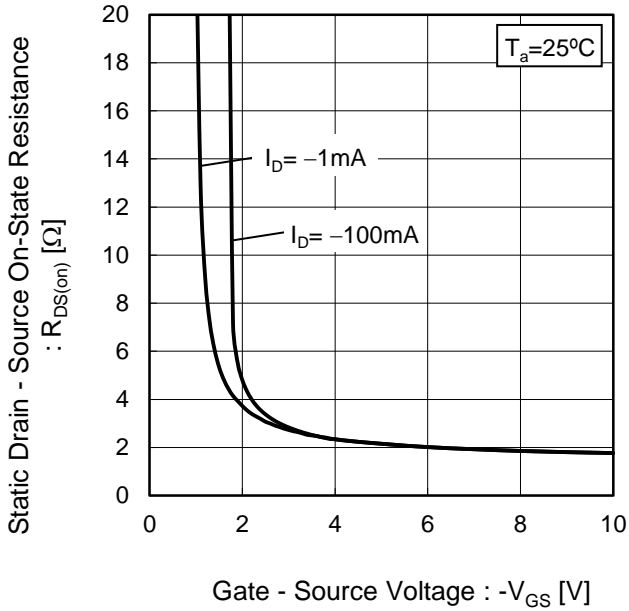

Fig.10 Static Drain - Source On - State Resistance vs. Drain Current(I)

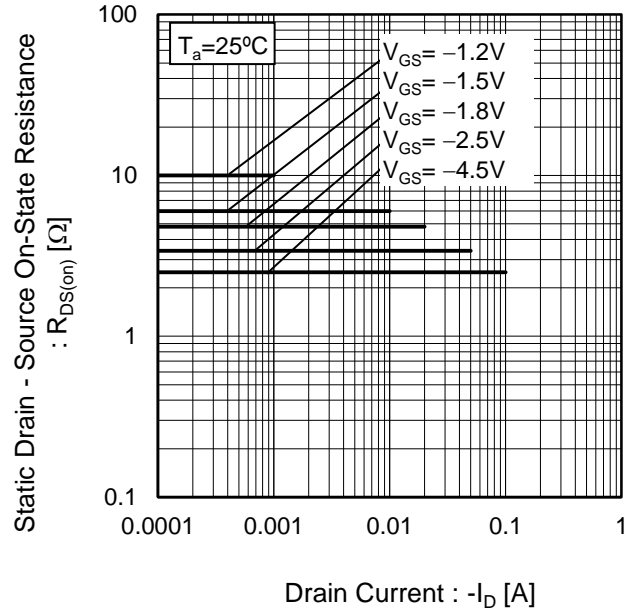

Fig.11 Static Drain - Source On - State Resistance vs. Junction Temperature

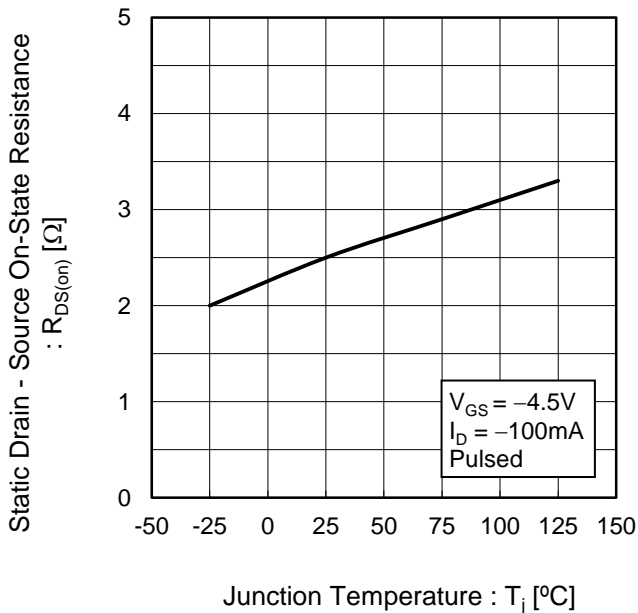
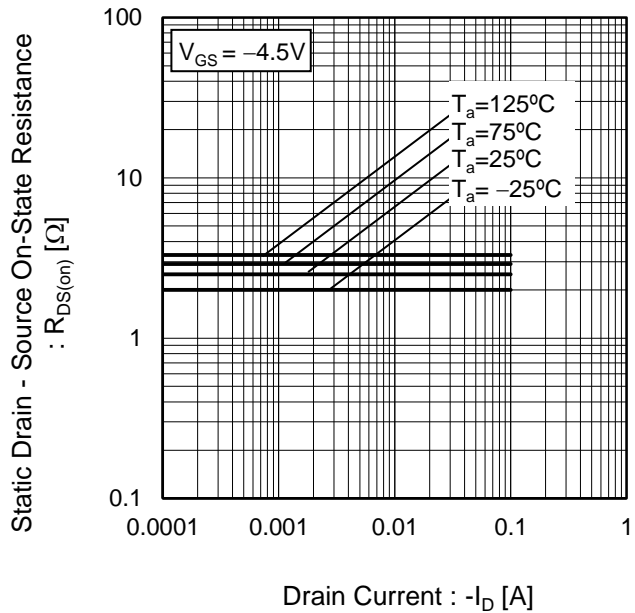

Fig.12 Static Drain - Source On - State Resistance vs. Drain Current(II)



●Electrical characteristic curves

Fig.13 Static Drain-Source On-State Resistance vs. Drain Current(III)

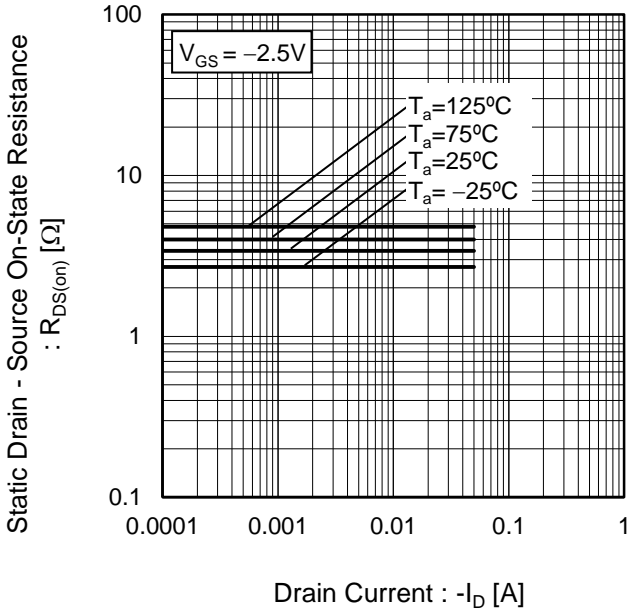

Fig.14 Static Drain - Source On - State Resistance vs. Drain Current(IV)

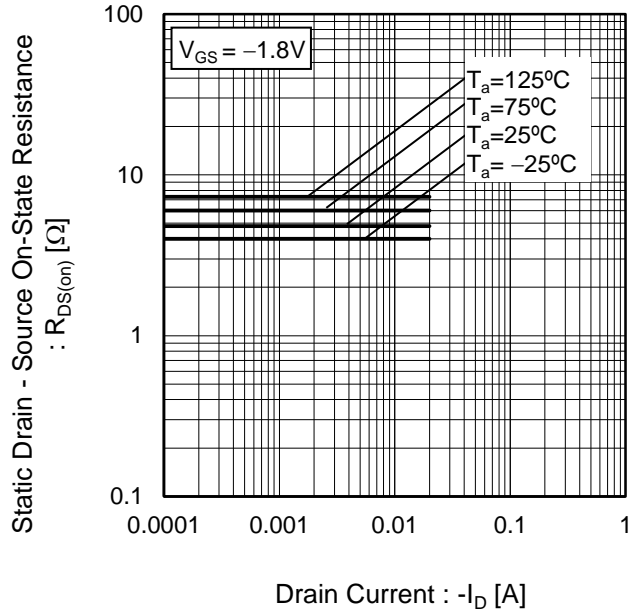

Fig.15 Static Drain - Source On - State Resistance vs. Drain Current(V)

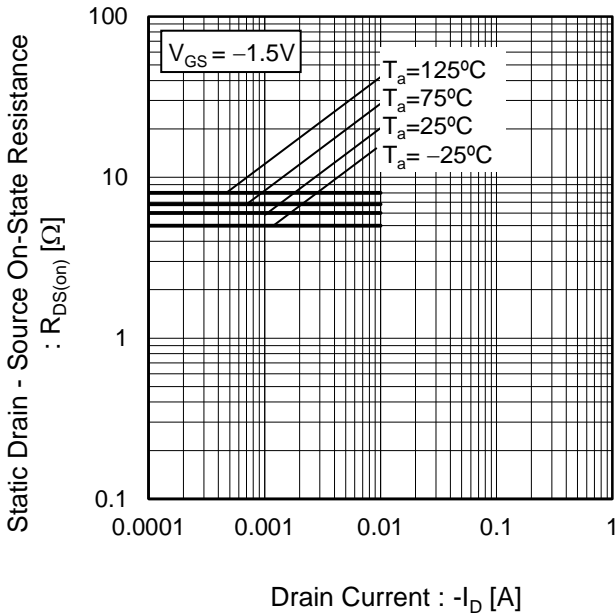
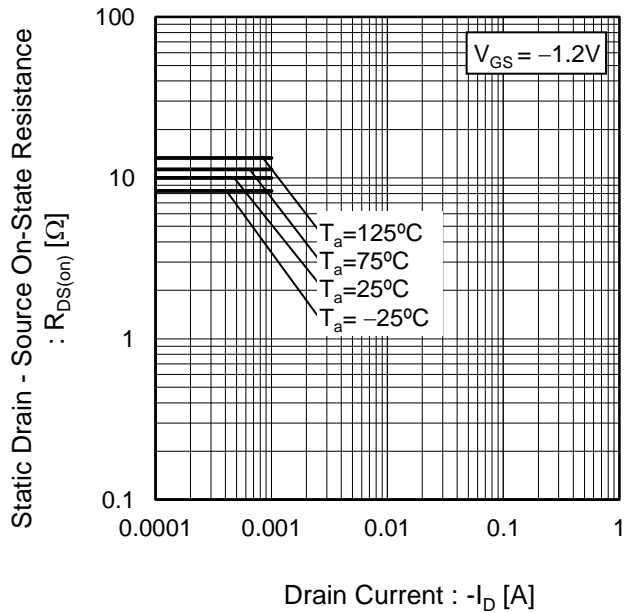

Fig.16 Static Drain - Source On - State Resistance vs. Drain Current(VI)



●Electrical characteristic curves

Fig.17 Typical Capacitance vs. Drain - Source Voltage

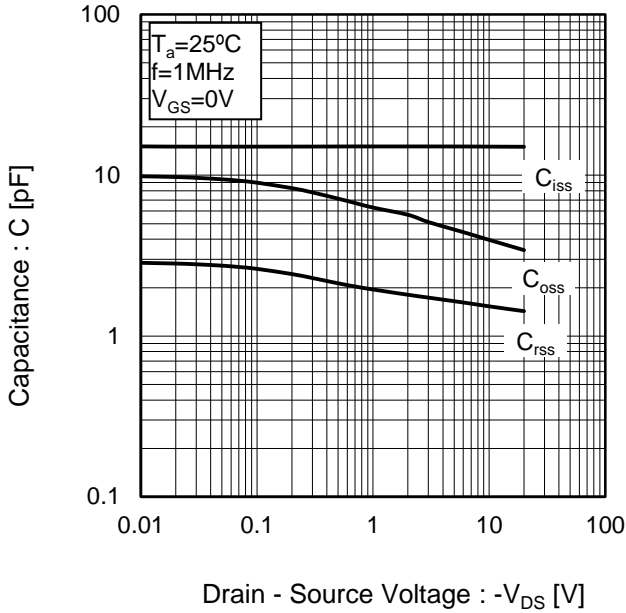

Fig.18 Switching Characteristics

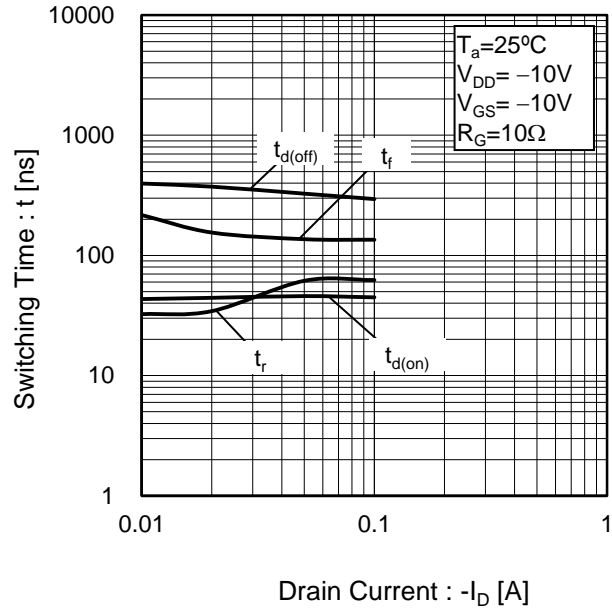
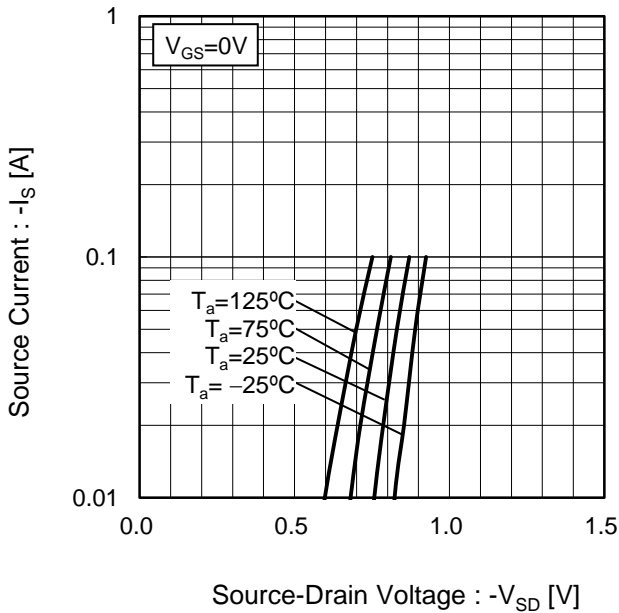

Fig.19 Source Current vs. Source Drain Voltage



●Measurement circuits

Fig.1-1 Switching Time Measurement Circuit

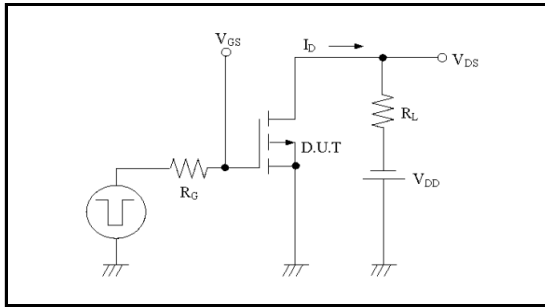
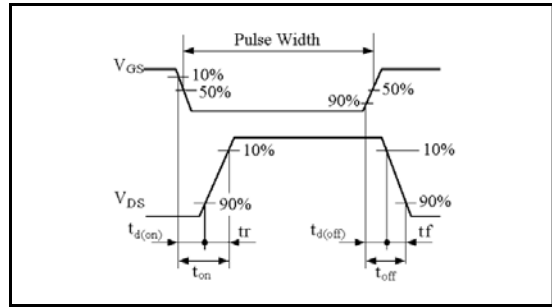
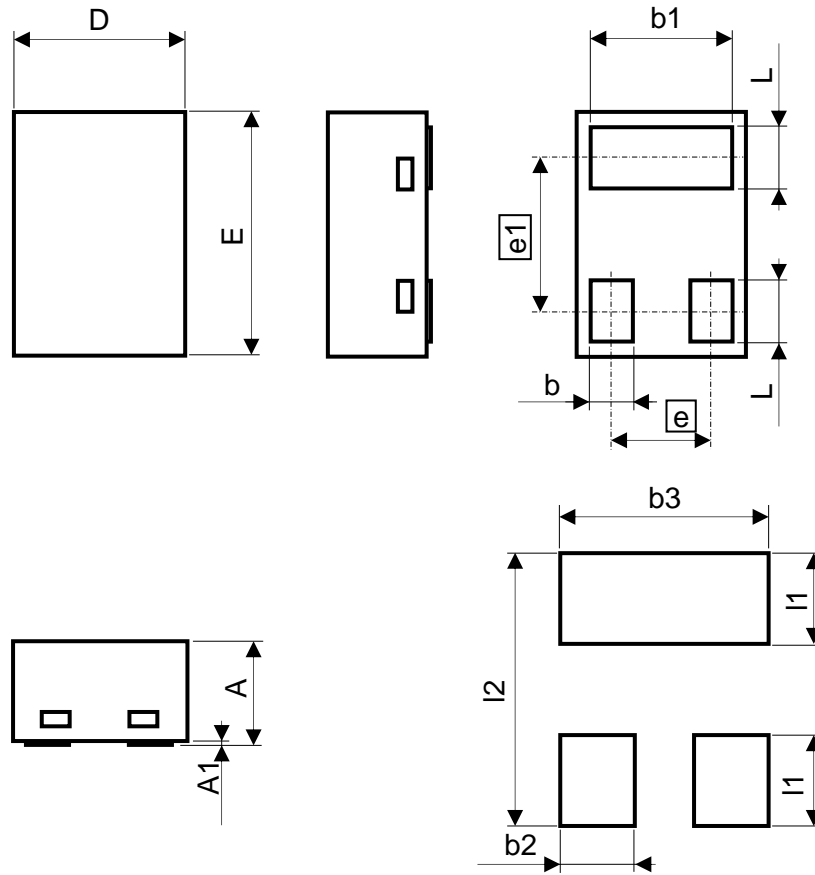

Fig.1-2 Switching Waveforms



●Dimensions (Unit : mm)

VML0806



Pattern of terminal position areas

DIM	MILIMETERS		INCHES	
	MIN	MAX	MIN	MAX
A	0.33	0.39	0.013	0.015
A1	0.00	0.05	0.000	0.002
b	0.10	0.20	0.004	0.008
b1	0.45	0.55	0.018	0.022
D	0.55	0.65	0.022	0.026
E	0.75	0.85	0.030	0.033
e	0.35		0.014	
e1	0.50		0.020	
L	0.15	0.25	0.006	0.010

DIM	MILIMETERS		INCHES	
	MIN	MAX	MIN	MAX
b2	-	0.25	-	0.010
b3	-	0.70	-	0.028
l1	-	0.30	-	0.012
l2	-	0.90	-	0.035

Dimension in mm/inches

Notes

- 1) The information contained herein is subject to change without notice.
- 2) Before you use our Products, please contact our sales representative and verify the latest specifications :
- 3) Although ROHM is continuously working to improve product reliability and quality, semiconductors can break down and malfunction due to various factors.
Therefore, in order to prevent personal injury or fire arising from failure, please take safety measures such as complying with the derating characteristics, implementing redundant and fire prevention designs, and utilizing backups and fail-safe procedures. ROHM shall have no responsibility for any damages arising out of the use of our Products beyond the rating specified by ROHM.
- 4) Examples of application circuits, circuit constants and any other information contained herein are provided only to illustrate the standard usage and operations of the Products. The peripheral conditions must be taken into account when designing circuits for mass production.
- 5) The technical information specified herein is intended only to show the typical functions of and examples of application circuits for the Products. ROHM does not grant you, explicitly or implicitly, any license to use or exercise intellectual property or other rights held by ROHM or any other parties. ROHM shall have no responsibility whatsoever for any dispute arising out of the use of such technical information.
- 6) The Products are intended for use in general electronic equipment (i.e. AV/OA devices, communication, consumer systems, gaming/entertainment sets) as well as the applications indicated in this document.
- 7) The Products specified in this document are not designed to be radiation tolerant.
- 8) For use of our Products in applications requiring a high degree of reliability (as exemplified below), please contact and consult with a ROHM representative : transportation equipment (i.e. cars, ships, trains), primary communication equipment, traffic lights, fire/crime prevention, safety equipment, medical systems, servers, solar cells, and power transmission systems.
- 9) Do not use our Products in applications requiring extremely high reliability, such as aerospace equipment, nuclear power control systems, and submarine repeaters.
- 10) ROHM shall have no responsibility for any damages or injury arising from non-compliance with the recommended usage conditions and specifications contained herein.
- 11) ROHM has used reasonable care to ensure the accuracy of the information contained in this document. However, ROHM does not warrant that such information is error-free, and ROHM shall have no responsibility for any damages arising from any inaccuracy or misprint of such information.
- 12) Please use the Products in accordance with any applicable environmental laws and regulations, such as the RoHS Directive. For more details, including RoHS compatibility, please contact a ROHM sales office. ROHM shall have no responsibility for any damages or losses resulting from non-compliance with any applicable laws or regulations.
- 13) When providing our Products and technologies contained in this document to other countries, you must abide by the procedures and provisions stipulated in all applicable export laws and regulations, including without limitation the US Export Administration Regulations and the Foreign Exchange and Foreign Trade Act.
- 14) This document, in part or in whole, may not be reprinted or reproduced without prior consent of ROHM.



Thank you for your accessing to ROHM product informations.
More detail product informations and catalogs are available, please contact us.

ROHM Customer Support System

<http://www.rohm.com/contact/>