

XSAV12373

inductive sensor XSAV - M30 - Sn10mm -
120..3000c/mn - 12..48VDC - cable 2m



Main

Range of product	OsiSense XS
Series name	Application
Sensor type	Inductive proximity sensor
Device application	Rotation monitoring
Sensor name	XSA
Sensor design	Cylindrical M30
Size	81 mm
Body type	Fixed
Detector flush mounting acceptance	Flush mountable
Material	Metal
Enclosure material	Nickel plated brass
Type of output signal	Discrete
Wiring technique	3-wire
[Sn] nominal sensing distance	10 mm
Discrete output function	1 NC
Output circuit type	DC
Discrete output type	PNP
Electrical connection	Cable
Cable length	2 m
[Us] rated supply voltage	12...48 V DC with reverse polarity protection
Switching capacity in mA	<= 200 mA with overload and short-circuit protection
IP degree of protection	IP67 conforming to IEC 60529

Complementary

Thread type	M30 x 1.5
Detection face	Frontal
Front material	PPS
Adjustable frequency range	120...3000 cyc/mn
Operating zone	0...8 mm
Differential travel	3...15% of Fr
Repeat accuracy	3% of Sr
Cable composition	3 x 0.34 mm ²
Wire insulation material	PvR
Status LED	1 LED red for output state
Supply voltage limits	10...58 V DC
Switching frequency	<= 800 Hz
Voltage drop	<= 1.8 V at closed state
Current consumption	0...15 mA at no-load
Run-up delay at power-up	9 s standard
Marking	CE
Threaded length	57 mm
Height	30 mm

Length	81 mm
Product weight	0.3 kg

Environment

Product certifications	CCC CSA UL
Ambient air temperature for operation	-25...70 °C

Offer Sustainability

Sustainable offer status	Green Premium product
RoHS (date code: YYWW)	Compliant - since 0825 - Schneider Electric declaration of conformity
REACH	Reference not containing SVHC above the threshold
Product environmental profile	Available Download Product Environmental
Product end of life instructions	Available Download End Of Life Manual

Dimensions

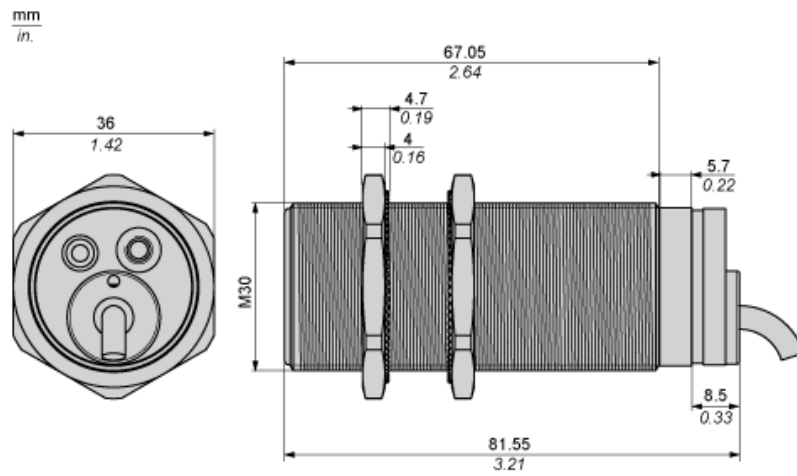

(1) LED

Minimum Mounting Distances

Side by side



e (1) 20 mm/0.79 in

≥

Face to face



e (2) 120 mm/4.72 in

≥

Facing a metal object



e (3) 30 mm/1.18 in.

≥

Wiring Schemes

3-wire DC

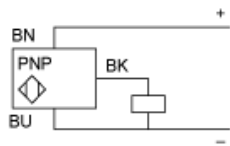

BU : Blue
BN : Brown
BK : Black

Performance Curves

Standard Steel Target : 30x30x1 mm



- (1) Pick-up points
- (2) Drop-out points (object approaching from the side)
- (y) Sensing distance in mm