

Pilot operated pressure reducing valves series ZDR are designed for maximum flow rates.

The reducing function can be located in the ports P, A or B. The sizes NG06 and NG10 are equipped with an integral return flow check valve (reducing function in A or B).

Features

- High flow capacity
- Pressure function in P, A or B
- With integral return flow check valve
- Sizes:
ZDR01 - NG06 (CETOP 03)
ZDR02 - NG10 (CETOP 05)



ZDR-P01

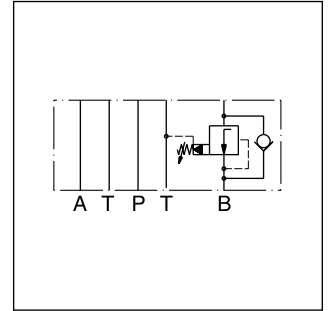

ZDR-B02

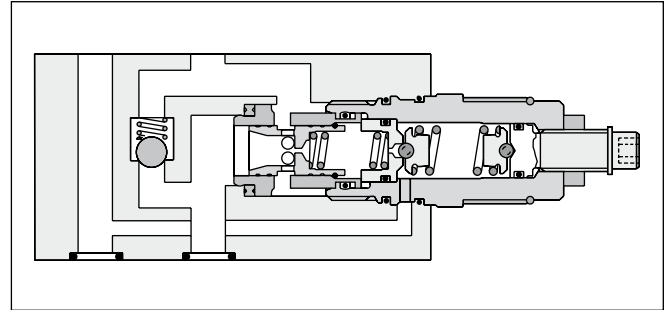

ZDR-B02

Ordering code

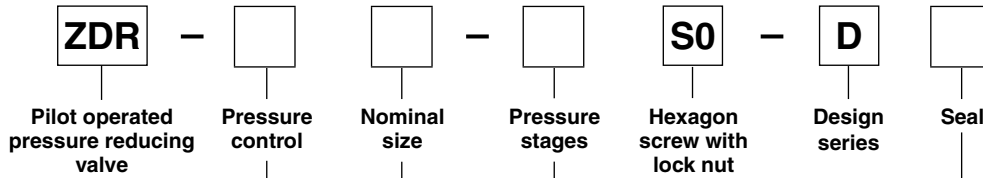

Code	Size	Pressure control
P	NG06/10	Pressure reducing in P with pressure gauge port M
AR	NG06/10	Pressure reducing in A with check valve
BR	NG06/10	Pressure reducing in B with check valve

Code	Seal
1	NBR
5	FPM

Code	Pressure stages
1	up to 70 bar
5 ¹⁾	up to 350 bar

Code	Nominal size
01	NG06
02	NG10

Ordering code details see end of chapter.

¹⁾ Code AR, BR and size 10 up to 315 bar.

Technical Data / Characteristic Curves

Technical data

General			
Size		NG06	NG10
Mounting interface		DIN 24340 A6 ISO 4401 NFPA D03	DIN 24340 A10 ISO 4401 NFPA D05
		CETOP RP 121	
Mounting position		unrestricted	
Ambient temperature	[°C]	-20...+50	
MTTF _D value	[years]	150	
Weight	ZDR-P [kg]	1.6	2.9
	ZDR-AR / BR [kg]	1.8	3.0
Hydraulic			
Max. operating pressure	[bar]	350 (ZDR-AR / BR 315)	315
Nominal flow	[l/min]	80	120
Pilot oil	[l/min]	0.3	0.3
Fluid		Hydraulic oil according to DIN 51524...51525	
Fluid temperature	[°C]	-20...+80	
Viscosity	permitted [cSt] / [mm ² /s]	10...650	
	recommended [cSt] / [mm ² /s]	30	
Filtration		ISO 4406 (1999); 18/16/13	

p/Q performance curves

ZDR-P/AR/BR01

7

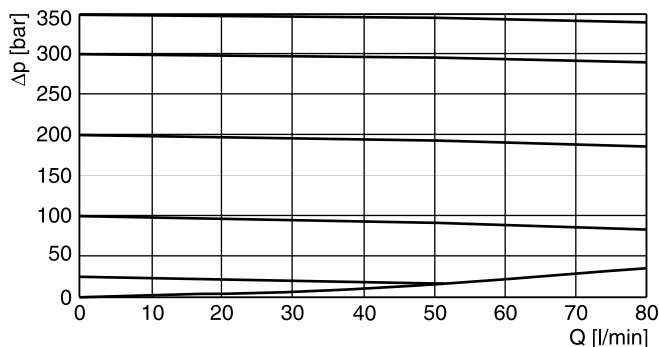

ZDR-P/AR/BR02

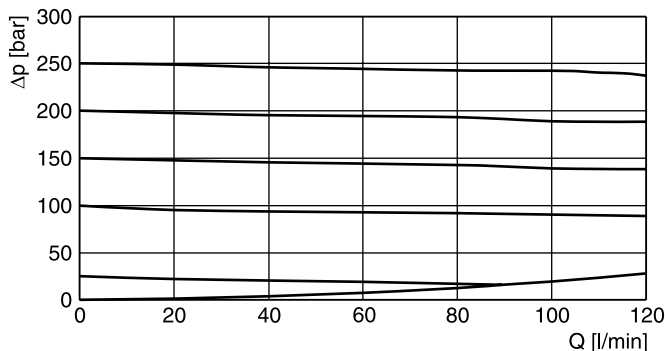

All characteristic curves measured with HLP46 at 50°C.

Dimensions

ZDR01

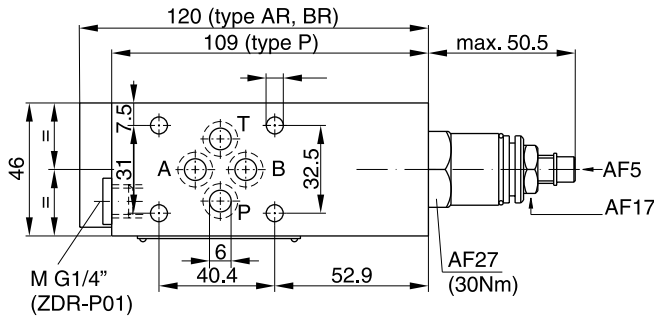

Seal kit	
Seal	Order code
1	098-91184-0
5	098-91185-0
Complete cartridge	
Pressure stage	Order code
1	098-91102-0
5	098-91103-0

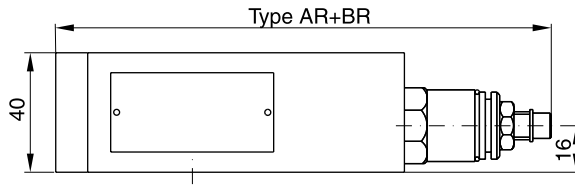
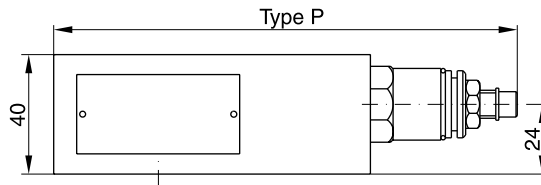

ZDR02

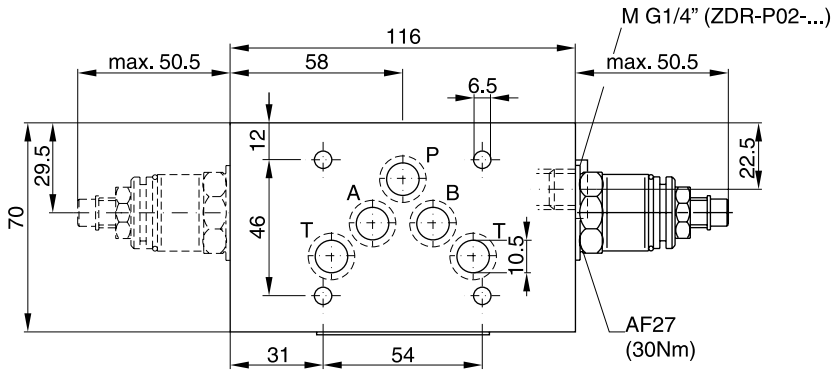

Seal kit	
Seal	Order code
1	098-91082-0
5	098-91083-0
Complete cartridge	
Pressure stage	Order code
1	098-91102-0
5	098-91103-0

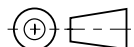
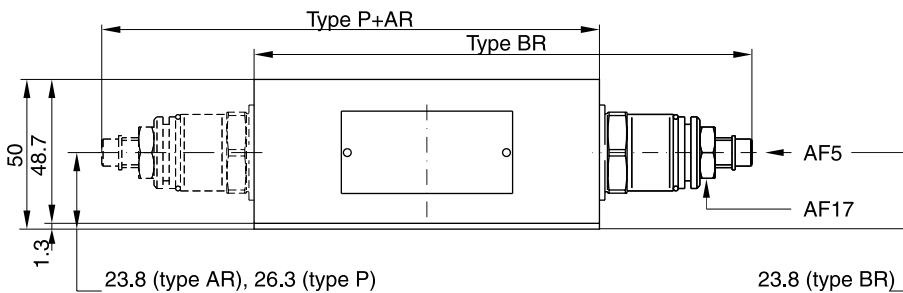

ZDR01

Pressure reducing in P
 with pressure gauge port M

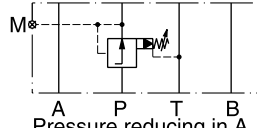

Series	Order No.
ZDR-P01-1-S0-D1	098-91179-0
ZDR-P01-5-S0-D1	098-91211-0

Pressure reducing in A
 with check valve

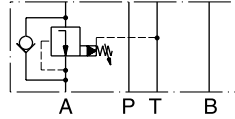

Series	Order No.
ZDR-AR01-1-S0-D1	098-91212-0
ZDR-AR01-5-S0-D1	098-91213-0

Pressure reducing in B
 with check valve

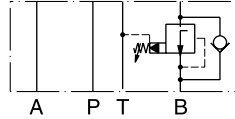

Series	Order No.
ZDR-BR01-1-S0-D1	098-91214-0
ZDR-BR01-5-S0-D1	098-91215-0

ZDR02

Pressure reducing at P
 (with pressure gauge port M)

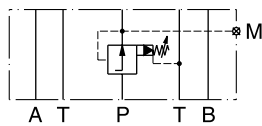

Series	Order No.
ZDR-P02-1-S0-D1	098-91050-0
ZDR-P02-5-S0-D1	098-91051-0

Pressure reducing at A
 (with check valve)

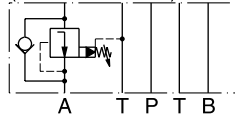

Series	Order No.
ZDR-AR02-1-S0-D1	098-91052-0
ZDR-AR02-5-S0-D1	098-91053-0

Pressure reducing at B
 (with check valve)

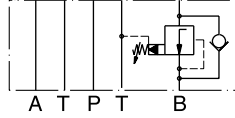

Series	Order No.
ZDR-BR02-1-S0-D1	098-91054-0
ZDR-BR02-5-S0-D1	098-91055-0

7